

PowerMax 1600/37 Art. 5037
 PowerMax 1800/42 Art. 5042

DE Betriebsanleitung
 Elektro-Rasenmäher

EN Operator's manual
 Electric Lawnmower

FR Mode d'emploi
 Tondeuse électrique

NL Gebruiksaanwijzing
 Elektrische grasmaaier

SV Bruksanvisning
 Elektrisk gräsklippare

DA Brugsanvisning
 Elektrisk plæneklipper

FI Käyttöohje
 Sähköruohonleikkuri

NO Bruksanvisning
 Elektrisk gressklipper

IT Istruzioni per l'uso
 Rasaerba elettrico

ES Instrucciones de empleo
 Cortacésped eléctrico

PT Manual de instruções
 Máquina de cortar relva elétrica

PL Instrukcja obsługi
 Kosiarka elektryczna

HU Használati utasítás
 Elektromos fűnyíró

CS Návod k obsluze
 Elektrická sekačka na trávu

SK Návod na obsluhu
 Elektrická kosačka

EL Οδηγίες χρήσης
 Ηλεκτρικό χλοοκοπτικό

RU Инструкция по эксплуатации
 Газонокосилка электрическая

SL Navodilo za uporabo
 Električna kosilnica

HR Upute za uporabu
 Električna kosilica za travu

SR/BS Uputstvo za rad
 Električna kosilica za travu

UK Інструкція з експлуатації
 Електрична газонокосарка

RO Instrucțiuni de utilizare
 Mașină de tuns iarbă electrică

TR Kullanma Kılavuzu
 Elektrikli çim biçme makinesi

BG Инструкция за експлоатация
 Електрическа косачка

SQ Manual përdorimi
 Korrëse bari elektrike

ET Kasutusjuhend
 Elektriline muruniiduk

LT Eksploatavimo instrukcija
 Elektrinė vejapjovė

LV Lietošanas instrukcija
 Elektriskais zāles pļāvējs

GARDENA Electric Lawnmower

PowerMax 1600/37 / PowerMax 1800/42

1. SAFETY	12
2. ASSEMBLY	14
3. OPERATION	15
4. MAINTENANCE	17
5. STORAGE	18
6. TROUBLESHOOTING	18
7. TECHNICAL DATA	19
8. ACCESSORIES	20
9. SERVICE/WARRANTY	20

Original instructions.



This product may be used under supervision, or if instruction regarding the safe use of the product has been provided and the resulting dangers have been understood, by children aged 8 and above, as well as by persons with physical, sensory or mental disabilities

or a lack of experience and knowledge. Children must not be allowed to play with the product. Cleaning and user maintenance must not be performed by children without supervision. The use of this product by young people under the age of 16 is not recommended.

Intended use:

The GARDENA Lawnmower is intended to mow lawn in private domestic gardens and allotments.

The product is not intended for long term use.

DANGER! Risk of injury! Do not use the product to cut bushes, hedges, shrubs, to cut off climbers or grass on roofs or balcony boxes, to chop up branches, twigs and to level irregularities in the soil. Do not use the product on a slope steeper than 20° maximum.

1. SAFETY

IMPORTANT!

Read the operator's manual carefully before use and keep for future reference.

Symbols on the product:



Read operator's manual.



Keep bystanders away.



Beware of sharp blades.
Blades continue to rotate after the motor is switched off.



Remove plug from mains before maintenance or if cord is damaged.



Keep supply flexible cord away from cutting means.

General safety warnings

Electrical safety



DANGER! Electric shock!

Risk of injury due to electric shock.

→ The product must be supplied through a residual current device (RCD) having a rated residual operating current not exceeding 30 mA.



DANGER! Risk of injury!

Cut injury when the blade turns or the product starts accidentally.

→ Disconnect the product from the mains before you do maintenance or you replace parts. Thereby the disconnected socket must be in the visual range.

Cabels

If extension cables are used, these must comply with the minimum cross-sections in the table below:

Voltage	Cable length	Cross section
220 – 240 V/50 Hz	Up to 20 m	1.5 mm ²
220 – 240 V/50 Hz	20 – 50 m	2.5 mm ²

- Mains cables and extensions are available from your local Approved Service Centre.
- Only use extension cables specifically designed for outdoor use and which conform to one of the following specifications:
Ordinary rubber (60245 IEC 53), Ordinary PVC (60227 IEC 53) or Ordinary PCP (60245 IEC 57).

3. If the short connection lead is damaged, it must be replaced by the manufacturer, its service agent or similarly qualified persons in order to avoid a hazard.

Training

- Read the instructions carefully. Be familiar with the controls and the correct use of the machine.
- Never allow children or people unfamiliar with these instructions to use the machine. Local regulations can restrict the age of the operator.
- Never operate the machine while people, especially children, or pets are nearby.
- Keep in mind that the operator or user is responsible for accidents or hazards occurring to other people or their property.

Preparation

- While operating the machine always wear substantial footwear and long trousers. Do not operate the machine when barefoot or wearing open sandals. Avoid wearing clothing that is loose fitting or that hanging cords or ties.
- Thoroughly inspect the area where the machine is to be used and remove all objects which can be thrown by the machine.
- Before using, always visually inspect to see that the blade, blade bolt and the blade assembly are not worn or damaged. Replace worn or damaged components in set to preserve balance. Replace damaged or unreadable labels.
- Before use check the supply and extension cord for signs of damage or aging. If the cord becomes damaged during use, disconnect the cord from the supply immediately. **DO NOT TOUCH THE CORD BEFORE DISCONNECTING THE SUPPLY.** Do not use the machine if the cord is damaged or worn.

Operation

- Operate the machine only in daylight or in good artificial light.
- Avoid operating the machine in wet grass.
- Always be sure of your footing on slopes.
- Walk, never run.
- Mow across the face of slopes, never up and down.
- Exercise extreme caution when changing direction on slopes.
- Do not mow excessively steep slopes.
- Use extreme caution when reversing or pulling the machine towards you.
- Stop the blade(s) if the machine has to be tilted for transportation, when crossing surfaces other than grass and when transporting the machine to and from area to be used.
- Never operate the machine with defective guards or shields, or without safety devices, for example deflectors and/or grass collector, in place.
- Switch on the motor carefully according to instructions and with feet well away from the blade(s).
- Do not tilt the machine when switching on the motor, except if the machine has to be tilted for starting. In this case, do not tilt it more than absolutely necessary and lift only the part, which is away from the operator.

- Do not start the machine when standing in front of the discharge opening.
- Do not put hands or feet near or under rotating parts. Keep clear of the discharge opening at all times.
- Do not transport the machine while the power source is running.
- Stop the machine, and remove plug from the socket. Make sure that all moving parts have come to a complete stop:
 - whenever you leave the machine,
 - before clearing blockages or unclogging chute,
 - before checking, cleaning or working on the machine,
 - after striking a foreign object. Inspect the machine for damage and make repairs before restarting and operating the machine;
 if the machine starts to vibrate abnormally (check immediately):
 - inspect for damage,
 - replace or repair any damaged parts,
 - check for and tighten any loose parts.

Maintenance and storage

- Keep all nuts, bolts, and screws tight to be sure the machine is in safe working condition.
- Check the grass collector frequently for wear or deterioration.
- Replace worn or damaged parts for safety.
- On machines with multi blade, take care as rotating one blade can cause other blades rotate.
- Be careful during adjustment of the machine to prevent entrapment of the fingers between moving blades and fixed parts of the machine.
- Always allow the machine to cool down before storing.
- When servicing the blades be aware that, even though the power source is switched off, the blades can still be moved.
- Use only genuine replacement parts and accessories.

Additional safety warnings

Electrical safety



DANGER! Cardiac arrest!

This product makes an electromagnetic field while it operates. This field may under some conditions interfere with active or passive medical implants. To decrease the risk of conditions that can possibly injure or kill, we recommend persons with medical implants to speak with their physician and the medical implant manufacturer before you operate the product.

Before use, examine the cable for signs of damage or ageing. If the cable is found to be defective, take the product to an authorised GARDENA Service Centre and have the cable replaced.

Do not use the product if the electric cables are damaged or worn.

Immediately disconnect from the mains if the cable is cut, or the insulation is damaged. Do not touch the electric cable until the cable has been disconnected. Do not repair a cut or damaged cable. Replace it with a new one.

The extension cable must be uncoiled. Coiled cables can overheat and reduce the efficiency of your mower. Keep the extension cable away from product, always work away from the power point mowing up and down, never in circles.

Do not pull cable around sharp objects.

Always switch off at the mains before disconnecting any plug, cable connector or extension cable.

Stop the engine, disconnect the mains and examine the cable for damage or ageing before you wind the cable for storage.

Do not repair a damaged cable, replace it with a new one. Use only genuine replacement cable.

Always wind the cable carefully, avoid kinking.

Do not carry the product by the cable.

Do not pull on the cable to disconnect any of the plugs.

Use only on AC mains supply voltage shown on the product rating label.

Our products are double insulated to EN 60335. Do not connect an earth to any part of the product.

Check the working area for hidden cables.

Do not use for pond care or close to water.

Personal safety



DANGER! Risk of suffocation!

Small parts can be easily swallowed. There is also a risk that the polybag can suffocate toddlers. Keep toddlers away when you assemble the product.

Do not use in explosive atmosphere.

Never operate the product when you are tired, ill or under the influence of alcohol, drugs or medicine.

Do not overload the mower.

Use gloves, wear slip resistant shoes and wear eye protection.

Do not use under wet conditions.

Do not disassemble the product further than the delivery status.

Only start the mower with an upright standing handle.

Use the handles carefully.

Safety Cut-Out

The engine is protected by a Safety Cut-Out which is activated when the blade becomes jammed or if the engine is overloaded. When this occurs, stop and disconnect the product from the mains. The Safety Cut-Out will only reset when you release the start/stop lever. Clear any obstruction and wait for a few minutes for the Safety Cut-Out to reset before you continue to use the product.

2. ASSEMBLY



DANGER! Risk of injury!

Cut injury when the mower starts accidentally.

→ **Wait for the blade to stop, disconnect the mower from the mains and use gloves before you assemble the mower.**

To assemble the handle:

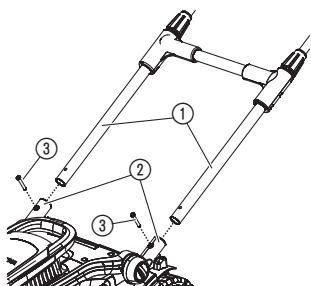

1. Push the handle ① into the openings ② in the mower.
Make sure that the handle ① is completely in place and the handle hole is in line up with the holes in the mower.
2. Put both screws ③ in the holes in the mower.
3. Tighten both screws ③ with a screwdriver.
Make sure that the screws ③ are completely tightened.

To attach the cable to the handle:

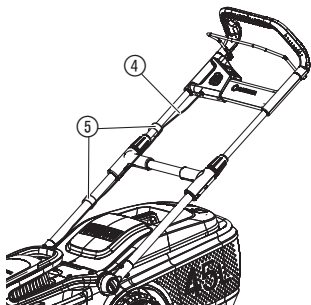

- Attach the cable ④ to the handle with the clamps ⑤.
Make sure that the cable is not locked between the handle and the mower.

To assemble the grass box:

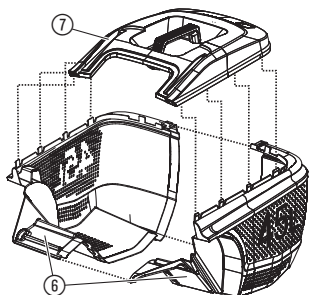

1. Connect both parts ⑥ of the grass box until the connections audibly engage.
Make sure that all connections are engaged.
2. Put the cover ⑦ on the grass box.
Make sure that the cover aligns to the grass box.
3. Push the cover ⑦ on the grass box until the connections audibly engage.
Make sure that all connections are engaged.

3. OPERATION



DANGER! Risk of injury!

Cut injury when the mower starts accidentally.

- Wait for the blade to stop, disconnect the mower from the mains and use gloves before you adjust or transport the mower.



DANGER! Risk of electric shock!

To avoid damage to the plug ⑧ the extension cable ⑨ must be inserted into the cable lock ⑩.

- Before you operate insert the extension cable ⑨ into the cable lock ⑩.

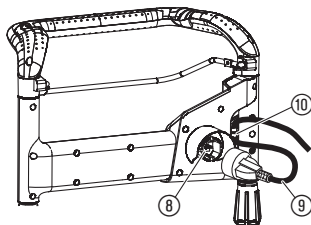

1. Connect the extension cable ⑨ to the plug ⑧.
2. Loop the extension cable ⑨, insert the loop into the cable lock ⑩ and pull tight.
3. Connect the extension cable ⑨ into a 230 V mains socket.

To start the mower:

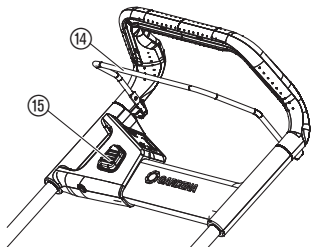

To adjust the handle length:

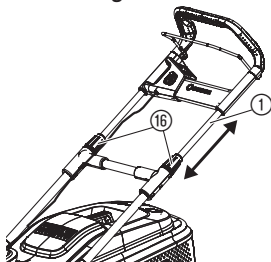

To adjust the cutting height:

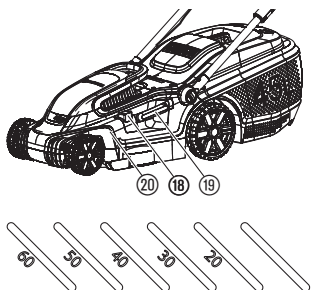

To use the mower with the grass box:



DANGER! Risk of injury!

Risk of injury if the mower does not stop when you release the start lever.

→ **Do not bypass the safety devices or switches. For example do not attach the start lever to the handle.**

To start:

The product is fitted with a two-handed safety device (start lever ⑭ and safety interlock ⑮) to prevent the product from being turned on by accident.

1. Push the safety interlock ⑮ with one hand and pull the start lever ⑭ with the other hand.
The mower starts.
2. Release the safety interlock ⑮.

To stop:

→ Release the start lever ⑭.
The mower stops.

The handle length can be adjusted to your body height.

1. Loosen both orange nuts ⑯.
2. Adjust the handle ① to the required length.
3. Tighten both orange nuts ⑯ again.

The cutting height can be adjusted from 20 – 60 mm in 5 positions.

1. Push the adjust button ⑱.
2. Hold the adjust lever ⑲ to adjust the cutting height.
3. Release the adjust lever ⑲ in the new position.



DANGER! Risk of injury!

Cut injury when the blade turns or the mower starts accidentally.

→ **Wait for the blade to stop, disconnect the mower from the mains and use gloves before you open the protective flap.**

→ **Do not put your hands in the discharge opening.**

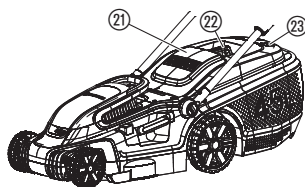

1. Lift the protective flap ②①.
2. Put the grass box into the mower by the handle ②②.
Make sure that the grass box is securely connected.
3. Start the mower.

The level indicator ②③ opens during mowing. When it closes during mowing the grass box is full.

4. Stop the mower.
5. Lift the protective flap ②①.
6. Remove the grass box by the handle ②②.
7. Empty the grass box.

Tips to use the mower:

If grass residue is left in the discharge opening, pull the mower backwards about 1 m so that the grass residue can drop out downwards.

To produce a well-maintained lawn, we recommend to cut the lawn regularly once a week if possible. The lawn becomes denser if you cut it frequently.

After relatively long cutting intervals (holiday lawn), first of all cut in one direction with the highest cutting height and then cut in the crosswise direction with the required cutting height.

If possible, only cut the grass when it is dry, if the grass is damp, the cutting pattern will be uneven.

4. MAINTENANCE



DANGER! Risk of injury!

Cut injury when the mower starts accidentally.

- Wait for the blade to stop, disconnect the mower from the mains and use gloves before you maintain the mower.

To clean the mower:



DANGER! Risk of injury!

Risk of injury and risk of damage to the mower.

- Do not clean the mower with water or with a water jet (in particular high-pressure water jet).
- Do not clean with chemicals including petrol or solvents. Some can destroy critical plastic parts.

The airflow slots must always be clean.

To clean the underside of the mower:

The underside is easiest to clean after you mowed.

1. Lay the mower on its side carefully.
2. Clean the underside, the blade and the discharge opening ②④ with a brush (do not use sharp objects).

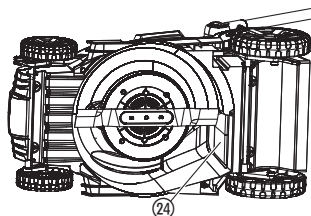

To clean the overside of the mower and the grass box:

1. Clean the overside with a damp cloth.
2. Clean the airflow slots and the grass box with a soft brush (do not use sharp objects).

5. STORAGE

To put into storage:

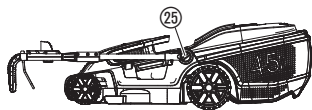

Disposal:
(in accordance with
RL2012/19/EC)



The product must be stored away from children.

1. Disconnect the product from the mains.
2. Clean the mower (see 4. MAINTENANCE).
3. To save space, loosen the lockings 25 until the handle can be folded easily.
Make sure that the cable is not locked between the handle and the mower.
4. Store the mower in a dry, enclosed and frost-free place.

The product must not be disposed of to normal household waste. It must be disposed of in line with local environmental regulations.

IMPORTANT!

Dispose of the product through or via your municipal recycling collection centre.

6. TROUBLESHOOTING



DANGER! Risk of injury!

Cut injury when the mower starts accidentally.

→ Wait for the blade to stop, disconnect the mower from the mains and use gloves before you troubleshoot the mower.

To replace the blade:



DANGER! Risk of injury!

Cut injury when the blade turns and it is damaged, bent, out of balance or has chipped edges.

→ Do not use the mower when the blade is damaged, bent, out of balance or has chipped edges.

→ Do not grind the blade.

The GARDENA spare parts are available from your GARDENA dealer or from the GARDENA service.

Only use an original GARDENA blade:

- For PowerMax 1600/37: GARDENA replacement blade Art. 4016.
- For PowerMax 1800/42: GARDENA replacement blade Art. 4017.

→ Let the blade be replaced by the GARDENA Service or a specialist dealer authorised by GARDENA.

Problem	Possible Cause	Remedy
Mower does not start	Extension cable is disconnected or damaged.	→ Connect the extension cable or if necessary replace it.
	Blade is blocked.	→ Remove the obstacle.
Engine is jammed and makes a noise	Blade is blocked.	→ Remove the obstacle.
	Cutting height is too low.	→ Raise the cutting height.

Problem	Possible Cause	Remedy
Loud noises, the mower is rattling	Screws on engine, its fixing or on the mower housing are loose.	→ Let the screws be tightened by an authorised specialist dealer or the GARDENA Service.
Mower runs unevenly or vibrates strongly	Blade is damaged/worn or the blade mounting is released.	→ Let the blade be tightened or replaced by an authorised specialist dealer or the GARDENA Service.
	Blade is very dirty.	→ Clean the mower (see 4. MAINTENANCE). If this does not rectify the problem, contact the GARDENA Service.
Lawn is not cleanly mowed	Blade is blunt or damaged.	→ Let the blade be replaced by the GARDENA Service.
	Cutting height is too low.	→ Raise the cutting height.



NOTE: For any other malfunctions please contact the GARDENA service department. Repairs must only be done by GARDENA service departments or specialist dealers approved by GARDENA.

7. TECHNICAL DATA

<i>Corded Lawnmower</i>	Unit	Value (Art. 5037)	Value (Art. 5042)
Rated power	W	1600	1800
Mains voltage	V (AC)	230	230
Mains frequency	Hz	50	50
Speed of rotation cutting blade	R/min	3200	3200
Cutting width	cm	37	42
Cutting height adjustment (5 positions)	mm	20 – 60	20 – 60
Volume of grass box	l	45	45
Weight	kg	13.7	15.2
Sound pressure level L_{pA}¹⁾ Uncertainty k_{pA}	dB (A)	84.7 3	84.4 3
Sound power level L_{WA}²⁾: measured/guaranteed Uncertainty k_{WA}	dB (A)	94.6 / 96 1.79	93.6 / 96 2.55
Hand/arm vibration a_{vhw}¹⁾ Uncertainty k_a	m/s ²	2.99 1.5	< 2.5 1.5

Measuring process complying with: ¹⁾ EN 60335-2-77 ²⁾ RL 2000/14/EC



NOTE: The stated vibration emission value has been measured according to a standardized test procedure and can be used for comparison of one electric power tool with another. It can also be used for preliminary evaluation of exposure. The vibration emission value can vary during actual use of the electric power tool.

8. ACCESSORIES

GARDENA Replacement Blade for PowerMax 1600/37 As replacement for blunt blade. **Art. 4016**

GARDENA Replacement Blade for PowerMax 1800/42 As replacement for blunt blade. **Art. 4017**

9. SERVICE/WARRANTY

Service:

Please contact the address on the back page.

Warranty:

In the event of a warranty claim, no charge is levied to you for the services provided.

GARDENA Manufacturing GmbH offers a two-year warranty (effective as of the date of purchase) for this product. This warranty includes all significant defects of the product that can be proved to be material or manufacturing faults. This warranty is fulfilled by supplying a fully functional replacement product or by repairing the faulty product sent to us free of charge; we reserve the right to choose between these options. This service is subject to the following provisions:

- The product was used for its intended purpose as per the recommendations in the operating instructions.

- Neither the purchaser nor a third party has attempted to repair the product.

This manufacturer's warranty does not affect warranty entitlements against the dealer/retailer.

If problems arise with this product, please contact our Service department or send the defective product along with a brief description of the fault to GARDENA Manufacturing GmbH, making sure to have sufficiently covered any shipping costs and to have followed the relevant postage and packaging guidelines. A warranty claim must be accompanied by a copy of the proof of purchase.

Consumables:

The blade and the wheels are consumables and are not included in the warranty.

DE Produkthaftung

Wir weisen ausdrücklich darauf hin, dass wir in Übereinstimmung mit dem Produkthaftungsgesetz nicht für Schäden haften, die durch unsere Produkte entstehen, wenn diese unsachgemäß und nicht durch einen von uns autorisierten Servicepartner repariert wurden oder wenn keine Original GARDENA Teile oder von uns zugelassene Teile verwendet wurden.

EN Product liability

In accordance with the German Product Liability Act, we hereby expressly declare that we accept no liability for damage incurred from our products where said products have not been properly repaired by a GARDENA-approved service partner or where original GARDENA parts or parts authorised by GARDENA were not used.

FR Responsabilité

Conformément à la loi relative à la responsabilité du fait des produits défectueux, nous déclarons expressément par la présente que nous déclinons toute responsabilité pour les dommages résultant de nos produits, si lesdits produits n'ont pas été correctement réparés par un partenaire d'entretien agréé GARDENA ou si des pièces d'origine GARDENA ou des pièces agréées GARDENA n'ont pas été utilisées.

NL Productaansprakelijkheid

Conform de Duitse wet inzake productaansprakelijkheid verklaren wij hierbij uitdrukkelijk dat wij geen aansprakelijkheid aanvaarden voor schade ontstaan uit onze producten waarbij deze producten niet zijn gerepareerd door een GARDENA-erkende servicepartner of waarbij geen originele GARDENA-onderdelen of onderdelen die door GARDENA zijn goedgekeurd zijn gebruikt.

SV Produktsvar

I enlighet med tyska produktsvarslagar förklarar vi härmed uttryckligen att vi inte åtar oss något ansvar för skador som orsakas av våra produkter där produkterna inte har genomgått korrekt reparation från en GARDENA-godkänd servicepartner eller där originaldelar från GARDENA eller delar godkända av GARDENA inte använts.

DA Produktsvar

I overensstemmelse med den tyske produktsvarslov erklærer vi hermed udtrykkeligt, at vi ikke påtager os noget ansvar for skader på vores produkter, hvis de pågældende produkter ikke er blevet repareret korrekt af en GARDENA-godkendt servicepartner, eller hvor der ikke er brugt originale GARDENA-reservedele eller godkendte reservedele fra GARDENA.

FI Tuotevastuu

Saksan tuotevastuulain mukaisesti emme ole vastuussa laitteiden vaurioista, jos korjauksia ei ole tehnyt GARDENAn hyväksymä huoltoliike tai jos niiden syynä on muiden kuin alkuperäisten GARDENA-varaosien tai GARDENAn hyväksymien varaosien käyttö.

IT Responsabilità del prodotto

In conformità con la Legge tedesca sulla responsabilità del prodotto, con la presente dichiariamo espressamente che decliniamo qualsiasi responsabilità per danni causati dai nostri prodotti qualora non siano stati correttamente riparati presso un partner di assistenza approvato GARDENA o laddove non siano stati utilizzati ricambi originali o autorizzati GARDENA.

ES Responsabilidad sobre el producto

De acuerdo con la Ley de responsabilidad sobre productos alemana, por la presente declaramos expresamente que no aceptamos ningún tipo de responsabilidad por los daños ocasionados por nuestros productos si dichos productos no han sido reparados por un socio de mantenimiento aprobado por GARDENA o si no se han utilizado piezas originales GARDENA o piezas autorizadas por GARDENA.

PT Responsabilidade pelo produto

De acordo com a lei alemã de responsabilidade pelo produto, declaramos que não nos responsabilizamos por danos causados pelos nossos produtos, caso os tais produtos não tenham sido devidamente reparados por um parceiro de assistência GARDENA aprovado ou se não tiverem sido utilizadas peças GARDENA originais ou peças autorizadas pela GARDENA.

PL Odpowiedzialność za produkt

Zgodnie z niemiecką ustawą o odpowiedzialności za produkt, niniejszym wyraźnie oświadczamy, że nie ponosimy żadnej odpowiedzialności za szkody poniesione na skutek użytkowania naszych produktów, w przypadku gdy naprawa tych produktów nie była odpowiednio przeprowadzana przez zatwierdzonego przez firmę GARDENA partnera serwisowego lub nie stosowano oryginalnych części GARDENA albo części autoryzowanych przez tę firmę.

HU Termékszavatosság

A németországi termékszavatossági törvénnyel összhangban ezzel nyomatékosan kijelentjük, hogy nem vállalunk felelősséget a termékeinkben keletkezett olyan károkért, amelyek valamely GARDENA által jóváhagyott szervizpartner által nem megfelelően végzett javításból adódtak, vagy amely során nem eredeti GARDENA alkatrészeket vagy a GARDENA által jóváhagyott alkatrészeket használtak fel.

CS Odpovědnost za výrobek

V souladu s německým zákonem o odpovědnosti za výrobek tímto výslovně prohlašujeme, že nepřijímáme žádnou odpovědnost za poškození vzniklá na našich výrobcích, kdy zmíněné výrobky nebyly řádně opraveny schváleným servisním partnerem GARDENA nebo kdy nebyly použity originální náhradní díly GARDENA nebo náhradní díly autorizované společností GARDENA.

SK Zodpovednosť za produkt

V súlade s nemeckými právnymi predpismi upravujúcimi zodpovednosť za výrobok týmto výslovne prehlasujeme, že nenesieme žiadnu zodpovednosť za škody spôsobené našimi výrobkami, v prípade ktorých neboli náležité opravy vykonané servisným partnerom schváleným spoločnosťou GARDENA alebo neboli použité diely spoločnosti GARDENA alebo diely schválené spoločnosťou GARDENA.

EL Ευθύνη προϊόντος

Σύμφωνα με τον γερμανικό νόμο περί Ευθύνης για τα Προϊόντα, με το παρόν δηλώνουμε ρητώς ότι δεν αποδεχόμαστε καμία ευθύνη για τυχόν ζημιές που προκύπτουν από τα προϊόντα μας εάν αυτά δεν έχουν επισκευαστεί σωστά από κάποιον εγκεκριμένο συνεργάτη επισκευών της GARDENA ή εάν δεν έχουν χρησιμοποιηθεί αυθεντικά εξαρτήματα GARDENA ή εξαρτήματα εγκεκριμένα από την GARDENA.

SL Odgovornost proizvajalca

V skladu z nemškimi zakoni o odgovornosti za izdelke, izrecno izjavljajo, da ne sprejemamo nobene odgovornosti za škodo, ki jo povzročijo naši izdelki, če teh niso ustrezno popravili GARDENINI odobreni servisni partnerji ali pri tem niso bili uporabljeni originalni GARDENINI nadomestni deli ali GARDENINIMI homologiranimi nadomestnimi deli.

HR Pouzdanost proizvoda

Sukladno njemačkom zakonu o pouzdanosti proizvoda, ovime izričito izjavljujemo kako ne prihvaćamo nikakvu odgovornost za oštećenja na našim proizvodima nastala uslijed neispravnog popravka od strane servisnog partnera kojeg odobrava GARDENA ili uslijed nekorištenja originalnih GARDENA dijelova ili dijelova koje odobrava GARDENA.

RO Răspunderea pentru produs

În conformitate cu Legea germană privind răspunderea pentru produs, declarăm în mod expres prin prezentul document că nu acceptăm nicio răspundere pentru defecțiunile suferite de produsele noastre atunci când acestea nu au fost reparate în mod corect de un atelier de service partener, aprobat de GARDENA, sau când nu au fost utilizate piese GARDENA originale sau piese autorizate de GARDENA.

BG Отговорност за вреди, причинени от стоки

Съгласно германския Закон за отговорността за вреди, причинени от стоки, с настоящото изрично декларираме, че не носим отговорност за щети, причинени от нашите продукти, ако те не са били правилно ремонтирани от одобрен от GARDENA сервиз или ако не са използвани оригинални части на GARDENA или части, одобрени от GARDENA.

ET Tootevastutus

Vastavalt Saksamaa tootevastutusseadusele deklareerime kaesolevaga selgesõnaliselt, et me ei kannu mingisugust vastutust meie toodetest tingitud kahjude eest, kui need tooted ei ole korrektselt parandatud GARDENA heakskiidetud hoolduspartneri poolt või kui parandamisel ei ole kasutatud GARDENA originaalosi või GARDENA volitatud osi.

LT Gaminio patikimumas

Mes aiškiai pareiškiame, kad, atsižvelgiant į Vokietijos gaminių patikimumo įstatymą, nepriisiame atsakomybės dėl bet kokios žalos, patirtos dėl mūsų gaminių, jeigu jie buvo netinkamai taisomi arba jų dalys buvo pakeistos neoriginaliomis GARDENA dalimis ar nepatvirtintomis dalimis, arba jeigu remonto darbai buvo atliekami ne GARDENA techninės priežiūros centro specialistų.

LV Atbildība par produkcijas kvalitāti

Saskaņā ar Vācijas likumu par atbildību par produkcijas kvalitāti ar šo mēs paziņojam, ka neuzņemamies atbildību par bojājumiem, kas radušies, lietojot mūsu izstrādājumus, kuru remontu nav veicis uzņēmuma GARDENA apstiprināts apkopes partneris vai kuru remontam netika izmantotas oriģinālās GARDENA detaļas vai detaļas, kuru lietošanu apstiprinājis uzņēmums GARDENA.

<p>DE EU-Konformitätserklärung</p> <p>Der Unterzeichner, Husqvarna AB, 561 82 Huskvarna, Schweden, bescheinigt hiermit, dass die nachstehend aufgeführten Geräte bei Verlassen des Werks die harmonisierten EU-Leitlinien, EU-Normen für Sicherheit und besondere Normen erfüllen. Dieses Zertifikat verliert seine Gültigkeit, wenn die Geräte ohne unsere Genehmigung verändert werden.</p>	<p>HU EK megfeleléségi nyilatkozat</p> <p>Alulírott Husqvarna AB, 561 82 Huskvarna, Svédország ezzel tanúsítja, hogy az alábbiakban leírt egységek a gyár elhagyásakor megfeleltek a harmonizált uniós előírásoknak és biztonsági és termékspecifikus szabványoknak. Ez a tanúsítvány érvényes veszt, ha az egységeket jóváhagyásunk nélkül átalakítják.</p>
<p>EN EC Declaration of Conformity</p> <p>The undersigned, Husqvarna AB, 561 82 Huskvarna, Sweden, hereby certifies that, when leaving our factory, the units indicated below are in accordance with the harmonised EU guidelines, EU standards of safety and product specific standards. This certificate becomes void if the units are modified without our approval.</p>	<p>CS Prohlášení o shodě ES</p> <p>Niže uvedená společnost Husqvarna AB, 561 82 Huskvarna, Švédsko, tímto potvrzuje, že při opuštění naší továrny jsou jednotky uvedené níže v souladu s harmonizačnými pokyny EU, standardy EU ohledně bezpečnosti a specifickými produktovými standardy. Tento certifikát pozbyvá platnosti, pokud dojde k úpravě jednotek bez našeho schválení.</p>
<p>FR Déclaration de conformité CE</p> <p>Le constructeur, soussigné : Husqvarna AB, 561 82 Huskvarna, Suède, déclare qu'à la sortie de ses usines le matériel neuf désigné ci-dessous était conforme aux prescriptions des directives européennes énoncées ciaprès et conforme aux règles de sécurité et autres règles qui lui sont applicables dans le cadre de l'Union européenne. Toute modification apportée à cet appareil sans notre accord annule la validité de ce certificat.</p>	<p>SK EÚ vyhlásenie o zhode</p> <p>Dolu podpísaná spoločnosť Husqvarna AB, 561 82 Huskvarna, Švédsko týmto osvedčuje, že nižšie uvedené jednotky boli v súlade s harmonizačnými usmerneniami EÚ, normami EÚ v oblasti bezpečnosti a špecifickými normami týkajúcimi sa produktu v čase opustenia výrobného závodu. Toto osvedčenie stráca platnosť, ak boli jednotky zmenené bez nášho súhlasu.</p>
<p>NL EG-conformiteitsverklaring</p> <p>De ondergetekende, Husqvarna AB, 561 82 Huskvarna, Zweden, verklaart hierbij dat de producten die hieronder staan vermeld, wanneer ze onze fabriek verlaten, in overeenstemming zijn met de geharmoniseerde Europese richtlijnen, EU-normen voor veiligheid en productspecifieke normen. Dit certificaat vervalt als de producten worden aangepast zonder onze toestemming.</p>	<p>EL Δήλωση Συμμόρφωσης EK</p> <p>Η υπογεγραμμένη εταιρεία, Husqvarna AB, 561 82 Huskvarna, Σουηδία, πιστοποιεί ότι, κατά την έξοδο από το εργοστάσιο, οι μονάδες που αναφέρονται κατωτέρω συμμορφώνονται με τις ευρωπαϊκές οδηγίες ΕΕ, τα πρότυπα ασφαλείας της ΕΕ και τα συγκεκριμένα πρότυπα προϊόντος. Αυτό το πιστοποιητικό καθίσταται άκυρο εάν οι μονάδες έχουν τροποποιηθεί χωρίς την έγκρισή μας.</p>
<p>SV EG-försäkran om överensstämmelse</p> <p>Undertecknad firma Husqvarna AB, 561 82 Huskvarna, Sverige, intygar härmed att nedan nämnda produkter, när de lämnar vår fabrik, överensstämmer med EU:s riktlinjer, EU:s säkerhetsstandarder och produktspecifika standarder. Detta intygg skall ogiltigförklaras om produkten ändras utan vårt godkännande.</p>	<p>SL Izjava ES o skladnosti</p> <p>Spodaj podpisana, Husqvarna AB, 561 82 Huskvarna, Švedska, s to izjavo potrjuje, da je bila spodaj navedena enota ob izhodu iz tovarne skladna z usklajalnimi smernicami EU, standardi EU za varnost in standardi, specifičnimi za izdelek. Izjava postane neveljavna v primeru neodobrene spremembe enote.</p>
<p>DA EU-øverensstemmelseserklæring</p> <p>Undertegnede, Husqvarna AB, 561 82 Huskvarna, Sverige erklærer hermed, at nedenfor anførte enheder er i overensstemmelse med de harmoniserede EU-rettningsslinjer, EU-standarder for sikkerhed og produktspecifikke standarder, når de forlader fabrikken. Denne erklæring ugyldiggøres, hvis enhederne ændres uden vores godkendelse.</p>	<p>HR Izjava o uskladenosti EZ</p> <p>Niže potpisana Husqvarna AB, 561 82 Huskvarna, Švedska, ovime potvrđuje kako su u nastavku navedene jedinice prilikom napuštanja tvornice bile u skladu s uskladenim smjernicama EU, EU sigurnosnim standardima i standardima specifičnima za proizvod. Ova certifikacija poništava se ako se jedinice izmjenjuju bez odobrenja.</p>
<p>FI EY-vaatimustenmukaisuusvakuutus</p> <p>Husqvarna AB, 561 82 Huskvarna, Ruotsi, vakuuttaa täten, että alla mainitut laitteet ovat tehtaalta lähtiesään yhdenmukaiset EU-säännösten, EU:n turva-standardien ja tuotekohtaisten standardien mukaisia. Tämä vakuutus mitätöityy, jos laitteita muokataan ilman hyväksyntäämme.</p>	<p>RO Declarație de conformitate CE</p> <p>Subscrisa, Husqvarna AB, 561 82 Huskvarna, Suedia, certifică prin prezenta că, la momentul ieșirii din fabrica noastră, unitățile indicate mai jos sunt în conformitate cu directivele UE armonizate, cu standardele UE de siguranță și cu standardele specifice ale produsului. Prezentul certificat devine nul dacă unitățile sunt modificate fără aprobarea noastră.</p>
<p>IT Dichiarazione di conformità CE</p> <p>La sottoscritta Husqvarna AB, 561 82 Huskvarna, Svezia, certifica che il prodotto qui di seguito indicato, nei modelli da noi commercializzati, è conforme alle direttive armonizzate UE nonché agli standard di sicurezza UE e agli standard specifici di prodotto. Qualunque modifica apportata al prodotto senza nostra specifica autorizzazione invalida la presente dichiarazione.</p>	<p>BG Декларация за съответствие на ЕО</p> <p>С настоящото долуподписаната, Husqvarna AB, 561 82 Huskvarna, Швеция, удостоверява, че при напускане на фабриката модулите, посочени по-долу, са в съответствие с хармонизираните директиви на ЕС, стандартите на ЕС за безопасност и специфичните за продукта стандарти. Този сертификат става невалиден, ако модулите са променени без нашето одобрение.</p>
<p>ES Declaración de conformidad CE</p> <p>El abajo firmante, Husqvarna AB, 561 82 Huskvarna, Suecia, certifica por la presente que, cuando salen de la fábrica, las unidades indicadas a continuación cumplen las normas de armonización de la UE, las normas de la UE sobre seguridad y las normas específicas del producto. Este certificado quedará sin efecto si se modifican las unidades sin nuestra autorización.</p>	<p>ET EÜ vastusdeklaratsioon</p> <p>Allkirjutatu Husqvarna AB, 561 82 Huskvarna, Rootsi, kinnitab käesolevaga, et tehased väljulehit vastavad alpool nimetatud seadmed harmoneeritud EL-i suunistele, EL-i ohutusstandarditele ja tootele eriomastele standarditele. See vastuskiinitus kaotab kehtivuse, kui seadet muudetakse ilma meie heakskiuduta.</p>
<p>PT Declaração de conformidade CE</p> <p>O abaixo assinado, Husqvarna AB, 561 82 Huskvarna, Suécia, certifica por este meio que, ao sair da nossa fábrica, as unidades indicadas acima estão em conformidade com as diretivas uniformizadas da UE, os padrões de segurança da UE e os padrões específicos do produto. Este certificado deixa de ser válido se as unidades forem modificadas sem a nossa aprovação.</p>	<p>LT EB atitikties deklaracija</p> <p>Husqvarna AB, 561 82 Huskvarna, Sweden, garantuoja, kad iš gamyklos siunčiami toliau nurodyti įrenginiai atitinka suderintus EB reikalavimus, EB saugos ir konkretaus gaminio standartus. Pakaitus gaminį be mūsų patvirtinimo, nutraukiamas šio sertifikato galiojimas.</p>
<p>PL Deklaracja zgodności WE</p> <p>Niżej podpisany przedstawiciel firmy Husqvarna AB, 561 82 Huskvarna, Szwecja, niniejszym oświadcza, że podane poniżej wyroby opuszczonej fabrykę są zgodne ze zharmonizowanymi normami UE oraz z obowiązującymi w UE przepisami bezpieczeństwa i normami dotyczącymi danego produktu. Modyfikacja wyrobów bez naszej zgody powoduje unieważnienie niniejszego certyfikatu.</p>	<p>LV EK atbilstības deklarācija</p> <p>Uzņēmums Husqvarna AB, 561 82 Huskvarna, Zviedrija, ir parakstu apliecinā, ka tālāk minētās vienības, pametot rūpnīcā, atbilst saskaitotajām ES vadlīnijām, ES drošības standartiem un iestrādājumiem specifiskajiem standartiem. Šis sertifikāts tiek anulēts, ja šīs vienības tiek modificētas bez mūsu apstiprinājuma.</p>

Produktbezeichnung: Description of the product: Désignation de produit : Productbenaming: Produktbeteckning: Produktbetegelse: Tuotenimike: Nome del prodotto: Designación del producto: Designação do produto: Opis produktu: A termék megnevezése: Označení produktu: Označenie výrobku: Ονομασία προϊόντος: Ime izdelka: Naziv proizvoda: Denumire produs: Описание на продукта: Toote nimetus: Gaminio pavadinimas: Izstrādājuma nosaukums:		Elektro-Rasenmäher Electric Lawnmower Tondeuse électrique Elektrische grasmaaier Elektrisk gräsklippare Elektrisk plæneklipper Sähköruohonleikkuri Rasaebera elettrico Cortacésped eléctrico Máquina de cortar relva elétrica Kosiarka elektryczna Elektromos fűnyíró Elektrická sekačka na trávu Kosiarka elektryczna Ηλεκτρικό γλοοκοπτικό Električna kosilnica Električna kosilica za travu Mašinā de tuns iarbā electricā Электрическа косачка Elektriline muruniiduk Elektrinė vejapjūvė Elektriskais zāles pļāvējs		Schall-Leistungspegel: Noise level: Niveau sonore : Geluidsniveau: Ljudnivå: Støjniveau: Äänitaso: Livello acustico: Nivel de ruido: Nivel de ruído: Poziom hałas: Zajszint: Hladina hluku: Hladiny hluku: Επίπεδο θορύβου: Raven zvočne moči: Razina buke: Nivel de zgomot: Ниво на шум: Műratase: Triukšmo lygis: Tröskļa līmenis :		gemessen/ garantiert measured/ guaranteed mesuré/ garanti gemeten/ gegarandeerd uppmätt/ garanterad målt/ garanteret mitattu/ taattu misurato/ garantito medido/ garantizado medido/ garantido zmierzony/ gwarantowany mért/ garantált naměřená/ zaručená namerané/ zaručené μετρημένο/ εγγυημένο izmerjena/ zagotovljena mjerena/ zajamčena măsurat/ garantat измерено/ гарантирано mődötvet/ garanteeitud išmatuotas/ garantuojamas mērītais/ garantētais	
Produkttyp: Product type: Type de produit : Producttype: Produkttyp: Produkttype: Tuotetyyppi: Tipo di prodotto: Tipo del producto: Tipo de produto: Typ produktu:		Terméktípus: Typ produktu: Typ výrobku: Τύπος προϊόντος: Tip izdelka: Tip proizvoda: Tip produs: Тип на продукта: Toote tüüp: Gaminio tipas: Izstrādājuma tips:		Artikelnummer: Article number: Référence : Artikelnummer: Artikelnummer: Artikelnummer: Artikelnummer: Número de artículo: Número de artículo: Número de referència: Numer katalogowy: Cikkszám: Číslo materiálu: Číslo výrobku: Αριθμός προϊόντος: Stevilka artikla: Broj artikla: Cod article: Артикулен номер: Artikli number: Gaminio numeris: Preces numurs:		Art. 5037 Art. 5042 94,6 dB(A) / 96 dB(A) 93,6 dB(A) / 96 dB(A) Anbringningsjahr der CE-Kennzeichnung: Year of CE marking: Année d'apposition du marquage CE : Installatiejaar van de CE-aanduiding: Märkningsår: CE-märkin kiinnitysvoosi: Anno di applicazione della certificazione CE: Colocación del distintivo CE: Ano de marcação pela CE: Rok nadania oznakowania CE: CE-jelzés elhelyezésének éve: Rok umístění značky CE: Rok udelenia značky CE: Έτος οήμωτος CE: Leto namestitve CE-oznake:	
EU-Richtlinien: EC-Directives: Directives UE : EU-richtlijnen: EU-riktlinjer: EU-direktiver: EU-direktiivit: Directive UE: Directivas de la UE: Diretivas UE: Dyrektywy UE: EU-irányelvek: Směrnicе EU: Smernice EU: Oδηγίες EE: EU-direktive: Direktive EU:		Directive EU: EC-Direktivi: EL-ι direktiivid: ES direktivos: ES direktivas: 2006/42/EC 2014/30/EC 2000/14/EC 2011/65/EC		2017			
Harmonisierte EN-Normen / Harmonised EN:		EN ISO 12100 EN 60335-1 EN 60335-2-77		Ulm, den 30.10.2017 Ulm, 30.10.2017 Fait à Ulm, le 30.10.2017 Ulm, 30-10-2017 Ulm, 2017.10.30. Ulm, 30.10.2017 Ulmissa, 30.10.2017 Ulm, 30.10.2017 Ulm, 30.10.2017 Ulm, 30.10.2017 Ulm, 30.10.2017 Ulm, dnia 30.10.2017 Ulm, 30.10.2017 Ulm, 30.10.2017 Ulm, dia 30.10.2017 Ulm, 30.10.2017 Ulm, 30.10.2017 Ulm, dana 30.10.2017 Ulm, 30.10.2017 Ulm, 30.10.2017 Ulm, 30.10.2017 Ulm, 30.10.2017 Ulme, 30.10.2017			
Hinterlegte Dokumentation: GARDENA Technische Dokumentation, M. Kugler 89079 Ulm		Konformitätsbewertungsverfahren: Nach 2000/14/EG Art. 14 Anhang VI		Der Bevollmächtigte Authorised representative Le mandataire De gevolmachtigde Auktoriserad representant Autoriseret repræsentrant Valtuutettu edustaja Persona delegata La persona autorizada O representante Pełnomocnik Meghatalmazott Zplnomocněnc Splnomocnený O εξουσιοδοτημένος Pooblaščenec Ovlaštena osoba Conducerea tehnică Упълномощен Volitatud esindaja Igalotisis atstovas Pilnvarotā persona			
Deposited Documentation: GARDENA Technical Documentation, M. Kugler 89079 Ulm		Conformity Assessment Procedure: according to 2000/14/EC Art.14 Annex VI		 Reinhard Pompe Vice President			
Documentation déposée: Documentation technique GARDENA, M. Kugler 89079 Ulm		Procédure d'évaluation de la conformité : Selon 2000/14/CE art. 14 Annexe VI					

Deutschland / Germany

GARDENA
Manufacturing GmbH
Central Service
Hans-Lorenser-Straße 40
D-89079 Ulm
Produktfragen:
(+49) 731 490-123
Reparaturen:
(+49) 731 490-290
service@gardena.com

Albania

COBALT Sh.p.k.
Rr. Siri Kodra
1000 Tirana

Argentina

Husqvarna Argentina S.A.
Av. del Libertador 5954 –
Piso 11 – Torre B
(C1428ARP) Buenos Aires
Phone: (+54) 11 5194 5000
info.gardena@
ar.husqvarna.com

Armenia

Garden Land Ltd.
61 Tigran Mets
0005 Yerevan

Australia

Husqvarna Australia Pty. Ltd.
Locked Bag 5
Central Coast BC
NSW 2252
Phone: (+61) (0) 2 4352 7400
customer.service@
husqvarna.com.au

Austria / Österreich

Husqvarna Austria GmbH
Industriezeile 36
4010 Linz
Tel.: (+43) 732 7701 01-485
service.gardena@
husqvarnagroup.com

Azerbaijan

Firm Progress
a. Aliyev Str. 26A
1052 Baku

Belgium

Husqvarna België nv/sa
Gardena Division
Rue Egide Van Opheim 111
1180 Uccle / Ukkel
Tel.: (+32) 2 720 92 12
info@gardena.be

Bosnia / Herzegovina

SILK TRADE d.o.o.
Industrijska zona Bukva bb
74260 Tešanj

Brazil

Husqvarna do Brasil Ltda
Av. Francisco Matarazzo,
1400 – 19º andar
São Paulo – SP
CEP: 05001-903
Tel: 0800-112252
marketing.br.husqvarna@
husqvarna.com.br

Bulgaria

AGROLAND България АД
бул. 8 Декември, №13
Офис 5
1700 Студентски град
София
Тел.: (+359) 246 669 10
info@agroland.eu

Canada / USA

GARDENA Canada Ltd.
100 Summerlea Road
Brampton, Ontario L6T 4X3
Phone: (+1) 905 792 9330
info@gardenacanada.com

Chile

Maquinarias Agroforestales
Ltda. (Maga Ltda.)
Santiago, Chile
Avda. Costeiron
8355 comuna Las Condes
Phone: (+56) 2 202 4417
Dalton@мага.cl
Zipcode: 7560330

China

Husqvarna (Shanghai)
Management Co., Ltd.
章世华 (上海) 管理有限公司
3F, Beng Square B
No.207, Song Hong Rd.,
Chang Ning District,
Shanghai, PRC, 200335
上海市长宁区沁虹路207号明
基广场B座3楼, 邮编: 200335

Colombia

Husqvarna Colombia S.A.
Calle 18 No. 68 D-31, zona
Industrial de Montevideo
Bogotá, Cundinamarca
Tel. 571 2922700 ext. 105
jairo.salazar@
husqvarna.com.co

Costa Rica

Compania Exim
Euroiberoamericana S.A.
Los Colegios, Moravia,
200 metros al Sur del Colegio
Saint Francis – San José
Phone: (+506) 297 68 83
exim_euro@racsa.co.cr

Croatia

SILK ADRIA d.o.o.
Josipa Lončara 3
10090 Zagreb
Phone: (+385) 1 3794 580
silk.adria@zg.t-com.hr

Cyprus

Med Marketing
17 Digeni Akrita Ave
P.O. Box 27017
1641 Nicosia

Czech Republic

Husqvarna Česko s.r.o.
Türkova 2319/5b
149 00 Praha 4 – Chodov
Bezplatná infolinka:
800 100 425
servis@cz.husqvarna.com

Denmark

GARDENA DANMARK
Lejrvvej 19, st.
3500 Værløse
Tlf.: (+45) 70264770
husqvarna@husqvarna.dk
www.gardena.com/dk

Dominican Republic

BOSQUESA, S.R.L.
Carretera Santiago Licey
Km. 5 ½
Esquina Copal II,
Santiago
Dominican Republic
Phone: (+809) 736-0333
joserbosquesa@claro.net.do

Ecuador

Husqvarna Ecuador S.A.
Arupos E1-181 y 10 de
Agosto Quito, Pichincha
Tel: (+593) 22800739
francisco.jacom@
husqvarna.com.ec

Estonia

Husqvarna Eesti OÜ
Gardena Division
Valdeku 132
Tallinn
11216, Estonia
info@gardena.ee

Finland

Oy Husqvarna Ab
Gardena Division
Lautatarhankatu 8 B / PL 3
00581 HELSINKI
info@gardena.fi

France

Husqvarna France
9/11 Allée des pierres mayettes
92635 Gennevilliers Cedex
France
http://www.gardena.com/fr
N° AZUR: 0 810 00 78 23
(Prix d'un appel local)

Georgia

ALD Group
Bellashvili 8
1159 Tbilisi

Great Britain

Husqvarna UK Ltd
Preston Road
Aycliffe Industrial Park
Newton Aycliffe
County Durham
DL5 6UP
info.gardena@
husqvarna.co.uk

ГРЕЦΙΑ

ΠΕΠΕ ΑΔΑΔΟΠΟΥΛΟΥ ΑΕΒΕ
Λεωφ. Αθηνών 92
Αθήνα
T.K. 104 2
Ελλάδα
Τηλ. (+30) 210 5193 100
info@papadopoulos.gr

Hungary

Husqvarna Magyarország Kft.
Ezred u. 1-3
1044 Budapest
Telefon: (+36) 1 251-4161
vevoszolgalat.husqvarna@
husqvarna.hu

Iceland

Josipa Lončara 3
10090 Zagreb
Phone: (+385) 1 3794 580
silk.adria@zg.t-com.hr

Ireland

Husqvarna UK Ltd
Preston Road
Aycliffe Industrial Park
Newton Aycliffe
County Durham
DL5 6UP
info.gardena@
husqvarna.co.uk

Italy

Husqvarna Italia S.p.A.
Via Santa Vecchia 15
23868 VALMADRERA (L.C.)
Phone: (+39) 0341.203.111
assistenza.italia@
it.husqvarna.com

JAPAN

KAKIUCHI Co. Ltd.
Sumitomo Realty &
Development Kojimachi
BLDG., 8F
5-1 Nibanncyo
Chiyoda-ku
Tokyo 102-0084
Phone: (+81) 33 264 4721
m_ishihara@kaku-ichi.co.jp

Kazakhstan

LAMED Ltd.
155/1, Tazhibayevoy Str.
050060 Almaty
IP Schmidt
Abayavenue 3B
110 005 Kostanay

Korea

Kyung Jin Trading CO., LTD.
107-4, SunDuk Bld.,
YangJae-dong,
Seochu-gu,
Seoul, (zipcode: 137-891)
Phone: (+82) (0)2 574-6300

Kyrgyzstan

Alye Maki
av. Molodaya Guardir J 3
720014
Bishkek

Latvia

Husqvarna Latvija SIA
Gardena Division
Ulbrokas 19A
LV-1021 Riga
info@gardena.lv

Lithuania

UAB Husqvarna Lietuva
Gardena Division
Atėities pl. 77C
LT-52104 Kaunas
info@gardena.lt

Luxembourg

Magasins Jules Neuberg
33 rue Jacques Stas
Luxembourg-Gasperich 2549
Case Postale No. 12
Luxembourg 2010
Phone: (+352) 40 14 01
api@neuberg.lu

Mexico

AFOSA
Av. Lopez Mateos Sur # 5019
Col. La Calma 45070
Zapopan, Jalisco
Mexico
Phone: (+52) 33 3818-3434
icornejo@afosa.com.mx

Moldova

Convel S.R.L.
290A Muncești Str.
2002 Chisinau

Netherlands

Husqvarna Nederland B.V.
GARDENA Division
Postbus 50131
1305 AC ALMERE
Phone: (+31) 36 521 00 10
info@gardena.nl

Neth. Antilles

Jonka Enterprises N.V.
St. Rosa Weg 196
P.O. Box 8200
Curaçao
Phone: (+599) 9 767 66 55
pgm@jonka.com

New Zealand

Husqvarna New Zealand Ltd.
PO Box 76-437
Manukau City 2241
Phone: (+64) (0) 9 9202410
support.nz@husqvarna.co.nz

Norway

Husqvarna Norge AS
Gardena Division
Trøskensveien 36
1708 Sarpsborg
Tel: 69 10 47 00
www.gardena.no

Peru

Husqvarna Perú S.A.
Jr. Ramón Cárcamo 710
Lima 1
Tel: (+51) 1 3320400 ext. 416
juan.rumzgo@
husqvarna.com

Poland

Husqvarna
Poland Spółka z o.o.
ul. Wysockiego 15 b
03-371 Warszawa
Phone: (+48) 22 330 96 00
gardena@husqvarna.com.pl

Portugal

Husqvarna Portugal, SA
Lagoa – Albarraque
2635 – 595 Rio de Mouro
Tel.: (+351) 21 922 85 30
Fax: (+351) 21 922 85 36
info@gardena.pt

Romania

Madex International Srl
Sosseua Odaii 117-123,
RO 013603 București, S 1
Phone: (+40) 21 352.76.03
madex@mes.ro

Russia / Россия

ООО „Хускварна“
141400, Московская обл.,
г. Химки,
улица Ленинградская,
владение 39, стр.6.
Бизнес Центр
„Химки Бизнес Парк“,
помещение 0B02.04
http://www.gardena.ru

Serbia

Dometl d.o.o.
Autoput za Novi Sad bb
11273 Belgrade
Phone: (+381) 118 488 88 12
miroslav.jejina@dometl.rs

Singapore

Hy-Ray PRIVATE LIMITED
40 Jalan Pemimpin
#02-09 Tat Ann Building
Singapore 577185
Phone: (+65) 6253 2277
shying@hyray.com.sg

Slovak Republic

Husqvarna Česko s.r.o.
Türkova 2319/5b
149 00 Praha 4 – Chodov
Bezplatná infolinka:
800 154 044
servis@sk.husqvarna.com

Slovenia

Husqvarna Austria GmbH
Industriezeile 36
4010 Linz
Tel.: (+43) 732 77 01 01-485
service.gardena@
husqvarnagroup.com

South Africa

Husqvarna
Husqvarna (Pty) Ltd
Postnet Suite 250
Private Bag X6,
Cascades, 3202
South Africa
Phone: (+27) 33 846 9700
info@gardena.co.za

Spain

Husqvarna España S.A.
Calle de Rivas n° 10
28052 Madrid
Phone: (+34) 91 708 05 00
atencioncliente@gardena.es

Suriname

Agrofix n.v.
Verlengde Hogestraat # 22
Breda
Phone: (+597) 472426
agrofix@sr.net
Pobox : 2006
Paramaribo
Suriname – South America

Sweden

Husqvarna AB
Gardena Division
S-561 82 Huskvarna
info@gardena.se

Switzerland / Schweiz

Husqvarna Schweiz AG
Consumer Products
Industriestrasse 10
5506 Mägenwil
Phone: (+41) (0) 62 887 37 90
info@gardena.ch

Turkey

Dost Bağcı Dış Ticaret
Müesseslik A.Ş
Yunus Mah. Adil Sok. No:3
İç Kapı No: 1 Kartal
34873 İstanbul
Phone: (+90) 216 38 93 939
info@dostbahca.com.tr

Ukraine / Україна

ТОВ „Хусварна Україна“
вул. Васильківська, 34,
офіс 204-г
03022, Київ
Тел. (+38) 044 498 39 02
info@gardena.ua

Uruguay

FELI SA
Entre Ríos 1083 CP 11800
Montevideo – Uruguay
Tel: (+598) 22 03 18 44
info@felisa.com.uy

Venezuela

Corporación Casa y Jardín C.A.
Av. Caroní, Edif. Trezmen, PB.
Colinas de Bello Monte,
1050 Caracas.
Tlf: (+58) 212 992 33 22
info@casayjardin.net.ve

5037-20.960.02/1017
© GARDENA
Manufacturing GmbH
D-89070 Ulm
http://www.gardena.com