

C 1030 plus Art. 1862

**GB Operating Instructions**  
Water Computer

**F Mode d'emploi**  
Programmateur d'arrosage

**NL Instructies voor gebruik**  
Besproeiingscomputer

**S Bruksanvisning**  
Bevattningscomputer

**DK Brugsanvisning**  
Vandingscomputer

**RUS Инструкция по эксплуатации**  
Компьютер для полива

# GARDENA Water Computer C 1030 plus

Welcome to the Garden of GARDENA...



Translation of the original instructions from German. Please read these operating instructions carefully and observe the notes given. Use these instructions to familiarise yourself with the Water Computer and its proper use as well as the notes on safety.



For safety reasons, children and young people under 16 as well as anyone who is not familiar with these operating instructions should not use the Water Computer.

→ Please keep these operating instructions in a safe place.

## Contents

1. Where to Use Your GARDENA Water Computer .....	2
2. Safety Instructions .....	2
3. Function .....	3
4. Putting Your Water Computer into Operation .....	5
5. Programming .....	6
6. Putting Your Water Computer out of Operation .....	10
7. Maintenance .....	10
8. Troubleshooting .....	11
9. Available Accessories .....	11
10. Technical Data .....	12
11. Service / Warranty .....	12

## 1. Where to Use Your GARDENA Water Computer

### Intended use:

The GARDENA Water Computer is intended for private use in domestic and hobby gardens, exclusively for outdoor use, to control sprinklers and watering systems. The Water Computer can be used for automatic watering during holidays.

### Please note:



**The GARDENA Water Computer must not be used for industrial purposes or in conjunction with chemicals, foodstuffs, easily flammable and explosive materials.**

## 2. Safety Instructions

### Battery:

**To ensure the Water Computer runs safely, only a 9V alkaline manganese battery (alkaline) type IEC 6LR61 must be used.**

In order to stop the Water Computer from failing because of a weak battery if you are away for a long time, the battery must be replaced when the battery display still shows only 1 bar.

### Setting up

#### Warning!

The Water Computer must not be used indoors.

→ Only use the Water Computer outdoors.

The Water Computer may only be set up vertically with the sleeve nut to the top to prevent water penetrating into the battery compartment.

The minimum water output to ensure that the Water Computer functions correctly is 20 - 30 l/h.

For example, at least 10 x 2-litre Drip Heads are required to control the Micro-Drip-System.

At high temperatures (over 60 °C at the display) the LCD display may extinguish. This does not affect the program in any way.

When the computer cools down the LCD display illuminates again.

The max. temperature for the water flow is 40 °C.

→ Only use clear fresh water.

The minimum operating pressure is 0.5 bar, the maximum operating pressure is 12 bar.

Avoid tensile strain.

→ Do not pull the hose connected to the Water Computer.

### Programming

→ Program the Water Computer with the tap turned off.

In this way you can avoid getting wet when trying out the manual On/Off function (man. On/Off). You can remove the control unit from the housing to program the Water Computer.

If the controller is removed when the valve is open, the valve remains open until the controller is fitted again.

## 3. Function

With the Water Computer, the garden can be watered fully automatically up to 3 times a day at any time of day (every 8 hours). Sprinklers, a sprinkler system or a drip head watering system can be used for watering.

The Water Computer carries out watering fully automatically according to the set program and can therefore also be used during holidays. Early in the morning or late in the evening, evaporation and therefore water consumption is lowest.

### Controls:

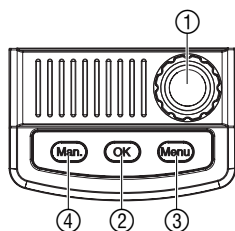

The watering programme is easily entered using the controls.

Control	Function
① <b>Rotary button</b>	Changes the adjustable values.
② <b>OK button</b>	Applies the values set with the rotary button.
③ <b>Menu button</b>	Changes to the next programme level.
④ <b>Man. button</b>	For switching the water throughput on or off manually.

### Display levels:

The 6 display levels,

- Level 1: **Normal display**
- Level 2: **Current time and day of the week**
- Level 3: **Watering start time**
- Level 4: **Watering duration**
- Level 5: **Watering frequency**
- Level 6: **Switches programme on and off**

can be selected one after the other by pressing the **Menu** key.

You can change the display level at any time, even during programming. All the programme data which have been confirmed up to that point with the O.K. key are stored.

**Display**

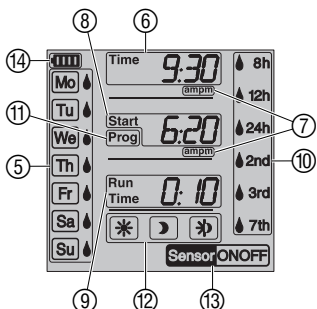

Display	Description
⑤ <b>Weekdays (Mo), (Tu), ...</b>	Current weekday or programmed watering days.
⑥ <b>Time</b>	Flashes when in input mode for the current data (hours, minutes, day of the week).
⑦ <b>am / pm</b>	Display for 12 hour clock (e. g. in USA, Canada).
⑧ <b>Start</b>	Flashes when in input mode for watering start time.
⑨ <b>Run Time</b>	Watering duration (flashes when in input mode).
⑩ <b>8h, 12h, 24h, 2nd, 3rd, 7th</b>	Watering cycle (with drop symbol activated). Every 8 / 12 / 24 hours; every 2nd / 3rd / 7th day.
⑪ <b>Prog ON / OFF</b>	Watering programme on ( <b>ON</b> ) / off ( <b>OFF</b> ).
⑫ <b>Automatic mode sensor</b>	Watering is controlled automatically via the sensor.
⑬ <b>Sensor ON / OFF</b>	Sensor <b>ON</b> (watering) / Sensor <b>OFF</b> (watering is not carried out).
⑭ <b>Battery </b>	Indicates 5 battery levels: 3 bars: Battery fully charged 2 bars: Battery half full 1 bar: Battery low 1 bar flashing: Battery almost flat 0 bar: Battery flat

If no bars are displayed, the valve is no longer opened. **A valve opened by the programme will also close again if the battery is flat.** The battery display is reset when the battery is changed.

2 Bars	1 Bar	1 Bar flashing	0 Bar
<b>Battery half full</b>	<b>Battery low</b>	<b>Battery almost flat</b>	<b>Battery flat</b>
Valve opens.	Valve opens.	Valve still opens.	Valve does not open.
The Water Computer is guaranteed to work for a minimum of 4 more weeks.	The Water Computer will continue to work for no more than 4 weeks.	The Water Computer stops working soon.	The Water Computer stops working.
	It is advisable to change the battery.	The battery must be changed soon.	The battery must be changed.
	→ Replace battery (see 4. Putting Your Water Computer into Operation "Inserting battery").		

## 4. Putting Your Water Computer into Operation

### Insert battery:

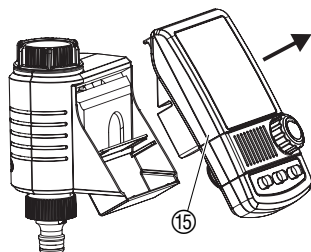

The Water Computer must only be operated with a 9 V alkali-manganese (alkaline) battery type IEC 6LR61.

1. Remove controller ⑮ from the housing of the Water Computer.
2. Insert battery in the battery compartment ⑯. **Observe correct polarity** Ⓟ. *The display shows all the LCD-symbols for 2 seconds and then moves to the time/day of week level.*

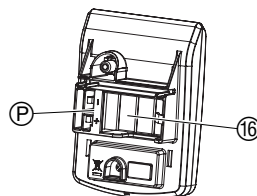

3. Install controller ⑮ on the housing again.

### Connect Water Computer:

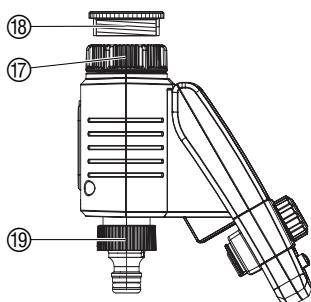

The Water Computer is fitted with a sleeve nut ⑰ for taps with (G 1") (33.3 mm) thread. The adaptor supplied ⑱ allows the Water Computer to be connected to taps with a (G 3/4") thread (26.5 mm).

1. **For tap with a G 3/4" (26.5 mm) thread:**  
Screw adaptor ⑱ on to the tap manually (do not use pliers).
2. Screw sleeve nut ⑰ of the Water Computer on to the adaptor thread by hand (do not use pliers).
3. Screw tap connector ⑲ on to the Water Computer.

### Connect soil moisture or rain sensor (optional):

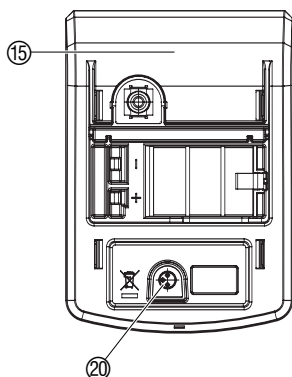

Apart from scheduled watering there is also the option of including how damp the soil is or rainfall into the watering programme.

If the soil is damp enough, the programme will be stopped, or a programme will be prevented from starting. Manual operation via Man. On / Off is unaffected by this.

The "Soil moisture sensor-controlled watering" mode can only be selected when using a soil moisture sensor.

1. Remove controller ⑮ from the housing of the Water Computer.
2. Place soil moisture sensor **in** the watered area  
– or –  
place rain sensor (with extension cable if necessary) **outside** the watered area.
3. Insert the sensor in the sensor connection ⑳ of the Water Computer.

An adapter cable may be required to connect older sensors, which can be purchased from GARDENA Service, **GARDENA Adapter cable Art. No. 1189-00.600.45.**

### Fit anti-theft device (optional):

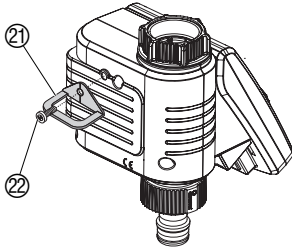

To secure your Water Computer against theft, you can obtain the **GARDENA Anti-theft device Art. No. 1815-00.791.00** from GARDENA Service.

1. Screw clamp ②① with screw ②② firmly to the back of the Water Computer.
2. Use clamp ②① e.g. for fixing a chain.

It is no longer possible to remove the screw after it has been screwed in.

## 5. Programming

### Set current time and day of week:

[Level 2]

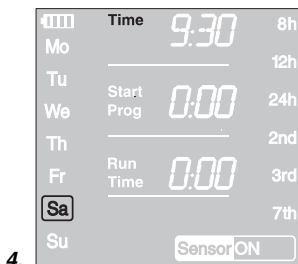
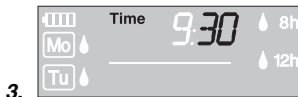
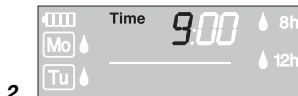

To set the programme, the controller can be removed and mobile programming can be carried out (see 4. Putting Your Water Computer into Operation "Inserting battery").

1. Press **Menu**-key (not necessary if the battery has just been inserted).

*The hours display and **Time** flash.*

2. Set the time in hours with the rotary button (example: **9** hours) and confirm with the **OK**-key.

***Time** and the minutes display flash.*

3. Set the time in minutes with the rotary button (example: **30** minutes) and confirm with the **OK**-key.

***Time** and the day of the week display flash.*

4. Set the day of the week with the rotary button (example: **Sa** Saturday) and confirm with the **OK**-key.

*The display moves to the message*

***Insert watering programme.***

***Start*** and the hour display will flash on the screen.

### Watering modes:

The water computer has 2 watering modes:

- **Scheduled watering** using the input programmes (watering starts depending on the watering start time)  
– or –
- **Soil moisture sensor-controlled watering** using a GARDENA soil moisture sensor (watering begins when the soil moisture sensor registers dry).

## Entering watering programme:

[Level 3]

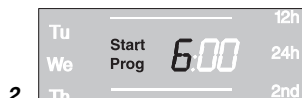

[Level 4]

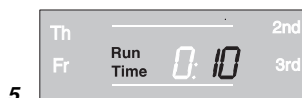

[Level 5]

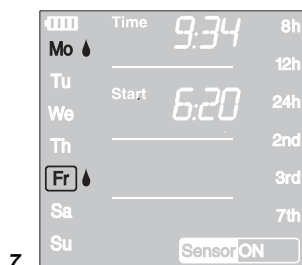
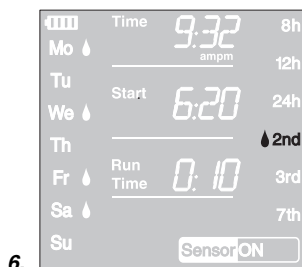

## Scheduled watering:

1. Press **Menu**-key twice (not necessary if the current time and day of the week has been entered).  
**Start Prog** and the hours section flash on the display.
2. Set the watering start time hours with the rotary button (E.g. **6**) and confirm with the **OK**-key.  
**Start Prog** and the minute display flashes on the screen.
3. Set the minutes for starting the watering time with the rotary button (example: **20** minutes) and confirm with the **OK**-key.  
**Run Time** and the hours for the watering time flash on the display.
4. Set the hours for the watering time with the rotary button (example: **0** hours) and confirm with the **OK**-key.  
**Run Time** and minutes for the watering time flash on the display.
5. Set watering time minutes with the rotary button (example: **10** minutes) and confirm with the **OK**-key.  
**Watering cycle** **8h** flashes on the display.

### The watering frequency can be selected by:

- the **(6.) watering cycle** (right hand column of the display)  
– or –
- the **(7.) watering days** (left hand column of the display).

6. Select **watering cycle** with the rotary button (E.g. 2nd ) and confirm by pressing **OK**.

**8h / 12h / 24 h:** Watering every 8 / 12 / 24 hours  
**2nd / 3rd / 7th:** Watering every 2nd / 3rd / 7th day

*The display jumps to the watering programme on the screen.*

– or –

7. Select each watering day with the rotary button

(E.g. **Mo**, **Fr** Monday and Friday) and confirm by pressing **OK**. Press the **Menu** button.

*The display jumps to the watering programme on the screen.*

## Starting watering programmes:

[Level 6]



The **Prog ON** must be selected so that the watering programme can start.

1. Press the **Menu** button 5 times (not necessary if the programme has been created before).
2. Select the **Prog ON** with the rotary button and confirm by pressing **OK**.

*The **Prog OK** appears for 2 seconds and then the **Normal display** returns.*

The water computer has now been programmed, i.e. the inbuilt valve opens and closes completely automatically and thus waters at the programmed time.

Even if **Prog OFF** is selected watering can be done manually.

## Soil moisture sensor-controlled watering

**Condition:** the GARDENA Soil Moisture Sensor **Art. 1188** is connected.

A previously set scheduled watering programme is retained but not carried out.

1. Hold the **Menu** button down for 5 seconds. *The watering cycle flashes.*
2. Select the required watering cycle with the rotary button (e.g. ☀ Day) and confirm with the **OK**-key.

**Day** ☀ Watering during the day (6 a.m. – 8 p.m.) when the soil moisture sensor registers dry.

**Night** ☾ Watering during the night (8 p.m. – 6 a.m.) when the soil moisture sensor registers dry.

**Day & Night** ☀☾ Watering when the soil moisture sensor registers dry.

3. Set the watering duration in minutes (0 – 59 minutes) with the rotary button (E.g. 40 minutes) and confirm by pressing **OK**. *Watering starts in the set watering cycle as soon as the soil moisture sensor registers dry (Sensor ON).*

The watering duration set in the sensor-controlled watering mode also applies to manual watering.

**In the case of soil moisture sensor-controlled watering, a two hour watering pause is triggered after every watering cycle in order for the soil moisture sensor to record the soil moisture.**

### Example:

Watering cycle = ☀ (Day),  
watering duration = 40 minutes.

Watering begins when the sensor registers dry (Sensor ON) during the day (between 6 a.m. and 8 p.m.) and ends up to 40 minutes later depending on the amount of moisture in the soil.



The watering duration is preset to 30 minutes at the factory.

**Emergency programme:** If no sensor is inserted in sensor-controlled watering mode or if the connection cable is faulty, watering will take place every 24 hours. The watering duration depends on the run time but is limited to a maximum of 30 minutes.

**Read / modify watering programmes:**



1. Press the **Menu** key twice.  
**Start and the hours flash on the display.**
2. Press the **Menu** button to jump to the next programme level  
– or –  
change the programme data with the rotary button and confirm by pressing the **OK** button.

If a value in the programme is to be changed, this can be changed without changing the other values in the programme.

**When the watering duration is changed while a program is running, the current watering cycle is ended.**

**Manual operation:**

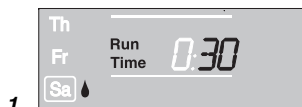

1. Press **Man.**-key to open the valve manually (or to close an open valve).  
**Run Time and the watering time in minutes (set to 30 minutes in the works) flash for 10 seconds on the display.**
2. Whilst the watering time in minutes is flashing, the watering duration can be modified with the rotary button (between **0:00** and **0:59**) (example: **10** minutes) and confirm with the **OK**-key.
3. Press **Man.**-key to close the valve early.  
*The valve is closed.*

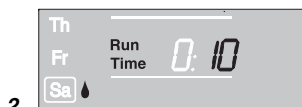

The valve can be **opened or closed manually at any time.** A program-controlled open valve can also be closed early without changing the program data (watering start time, watering duration and watering frequency). The controller must be fitted.

The amended manual opening period is stored, i.e. each time the valve is opened manually in future the modified opening period is preset. If the manual opening period is amended to **0:00**, the valve is closed and also remains closed after the **Man.**-key is pressed (child lock).

If the valve has been opened manually and a programmed start of a watering period overlaps the manual opening period, the programmed starting time is suppressed.

**Example:**

The valve is **opened at 9.00 a.m. manually**, the opening period is 30 minutes. A program with a **start time (START) between 9.00 and 9.30 a.m.** will not be undertaken in this case.

**Reset:**

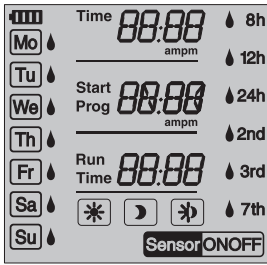

The factory settings are restored.

→ Press **Man.**-key and **Menu**-key simultaneously for 3 seconds.  
*All the LCD symbols are displayed for 2 seconds and the display moves to the normal display.*

- All the program data are set to zero.
- The manual watering period is set to **0:30** again.
- The time and day of the week are retained.

**Important information:**

If no entry is made during programming for a period of more than 60 seconds, the normal display reappears. In this case all changes made up till now will be applied.

When a sensor installed in the water computer registers damp (**OFF**), the programmed watering is not carried out.

## 6. Putting Your Water Computer out of Operation

**Storage / Overwintering:**



1. Press **Menu**-key 5 times, select **Prog. OFF** with the rotary button and confirm with the **OK**-key.  
*The watering program is not run.*
2. Store your Water Computer in a dry place where it is protected from frost.

**Disposal:**  
*(in accordance with RL2002/96/EC)*



The product must not be added to normal household waste. It must be disposed of in line with local environmental regulations.  
 → Important: Make sure that the unit is disposed of via your municipal recycling collection centre.

**Disposing of flat batteries:**

→ Please return flat batteries to a GARDENA dealer or dispose of them properly at your nearest recycling centre.  
 Only dispose of batteries when they are **flat**.

## 7. Maintenance

**Clean filter:**

The filter 23 should be checked regularly and cleaned when necessary.

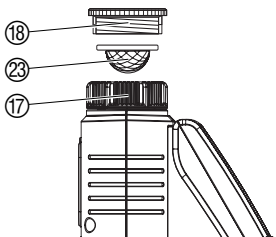

1. Unscrew sleeve nut 17 of the Water Computer by hand from the tap thread (do not use pliers).
2. If necessary unscrew the adaptor 18.
3. Remove filter 23 from sleeve nut 17 and clean.
4. Fit the Water Computer again (see 4. Putting Your Water Computer into Operation "Connecting Water Computer").

## 8. Troubleshooting

Fault	Possible Cause	Remedy
No display appears	Battery inserted incorrectly.	→ Check polarity markings match (+/-).
	Flat battery.	→ Insert new (alkaline) battery.
	Temperature on the display is higher than 60 °C.	Display appears after temperature has dropped.
Manual watering is not possible using the Man. button	Battery flat (1 bar flashes).	→ Insert new (alkaline) battery.
	Manual watering period is set to <b>0:00</b> .	→ Set manual watering period to a figure greater than <b>0:00</b> (see 5. Programming).
	Tap turned off.	→ Turn tap on.
Watering program is not being undertaken (no watering)	Watering program has not been entered completely.	→ Read off watering program and modify if necessary.
	Programs deactivated ( <b>Prog. OFF</b> ).	→ Activate program ( <b>Prog. ON</b> ).
	Program entry/modification during or just before the start pulse.	→ Make program entry/modification outside the programmed start times.
	Valve was opened manually previously.	→ Avoid possible program overlaps.
	Tap turned off.	→ Turn tap on.
	Soil moisture or rain sensor registers damp.	→ If dry, check setting/location of soil moisture/rain sensor.
	Battery flat (1 bar flashing).	→ Insert new (alkaline) battery.
Water Computer does not close	Minimum quantity of water drawn is less than 20 l/h.	→ Connect more drip heads.
All 3 watering cycle symbols flash (☒ ☑ ☒)	Sensor not correctly connected.	→ Check connection cable and sensor.



In the event of other faults please contact GARDENA Service.  
Repairs should only be carried out by GARDENA service centres or dealers authorised by GARDENA.

## 9. Available accessories

GARDENA Soil Moisture Sensor	Art. No. 1188
GARDENA Rain Sensor electronic	Art. No. 1189
GARDENA Anti-theft device	Art. No. 1815-00.791.00 From GARDENA Service

**GARDENA**  
Adapter cable

To connect older GARDENA  
sensors

**Art. No. 1189-00.600.45**  
From GARDENA Service

**GARDENA**  
Cable Adapter

For simultaneous connection of  
rain and soil moisture sensor

From GARDENA Service

## 10. Technical Data

<b>Min./max. operating pressure:</b>	0.5 bar / 12 bar
<b>Flow medium:</b>	Clear fresh water
<b>Max. liquid temperature:</b>	40 °C
<b>Number of program-controlled watering cycles per day:</b>	3 x (every 8 hrs.), 2 x (every 12 hrs.), 1 x (every 24 hrs.)
<b>Number of program-controlled watering cycles per week:</b>	Every day, every 2, 3 or 7 days; or individual selection of weekdays
<b>Watering duration:</b>	1 min. to 7 hours 59 min.
<b>Battery required:</b>	1 × 9V alkaline manganese (alkaline) battery type IEC 6LR61
<b>Operating time of the battery:</b>	approx. 1 year

## 11. Service / Warranty

GARDENA guarantees this product for 2 years (from date of purchase). This guarantee covers all serious defects of the unit that can be proved to be material or manufacturing faults.

Under warranty we will either replace the unit or repair it free of charge if the following conditions apply:

- The unit must have been handled properly and in keeping with the requirements of the operating instructions.
- Neither the purchaser or a non-authorized third party have attempted to repair the unit.
- Faults which occur as a result of incorrectly installed or leaking batteries are not covered by the guarantee.
- Damage caused by frost is not covered by the warranty.

This manufacturer's guarantee does not affect the user's existing warranty claims against the dealer/seller.

If you have any problems with your Water Computer, please contact our Customer Service or return the defective unit together with a short description of the problem directly to one of the GARDENA Service Centres listed on the back of this leaflet.

<p><b>GB EU Certificate of Conformity</b></p> <p>The undersigned GARDENA International GmbH, Hans-Lorenser-Str. 40, D-89079 Ulm, hereby certifies that, when leaving our factory, the units indicated below are in accordance with the harmonised EU guidelines, EU standards of safety and product specific standards. This certificate becomes void if the units are modified without our approval.</p>	<p>Description of the unit: Water Computer          Désignation du matériel : Programmeur d'arrosage          Omschrijving van het apparaat : Besproeiingscomputer          Produktbeskrivning: Bevattningscomputer          Beskrivelse af enhederne : Vandingscomputer          Название устройства : Компьютер для полива</p>
<p><b>F Certificat de conformité aux directives européennes</b></p> <p>Le constructeur, soussigné : GARDENA Manufacturing GmbH, Hans-Lorenser-Str. 40, D-89079 Ulm, déclare qu'à la sortie de ses usines le matériel neuf désigné ci-dessous était conforme aux prescriptions des directives européennes énoncées ci-après et conforme aux règles de sécurité et autres règles qui lui sont applicables dans le cadre de l'Union européenne. Toute modification portée sur ce produit sans l'accord express de GARDENA supprime la validité de ce certificat.</p>	<p>Type :          Type :          Typ : <b>C 1030 plus</b>          Typ :          Type :          Тип :</p> <p>Art. No. :          Référence :          Art. nr. : <b>1862</b>          Art. nr. :          Varenr. :          Арт. № :</p>
<p><b>NL EU-overeenstemmingsverklaring</b></p> <p>Ondergetekende GARDENA Manufacturing GmbH, Hans-Lorenser-Str. 40, D-89079 Ulm, bevestigt, dat het volgende genoemde apparaat in de door ons in de handel gebrachte uitvoering voldoet aan de eisen van, en in overeenstemming is met de EU-richtlijnen, de EU-veiligheidsstandaard en de voor het product specifieke standaard. Bij een niet met ons afgestemde verandering aan het apparaat verliest deze verklaring haar geldigheid.</p>	<p>EU directives :          Directives européennes : <b>2004/108/EC</b>          EU-richtlijnen :          EU direktiv : <b>93/68/EC</b>          EU Retningslinier :          Директивы ЕС :</p>
<p><b>S EU Tillverkarintyg</b></p> <p>Undertecknad firma GARDENA International GmbH, Hans-Lorenser-Str. 40, D-89079 Ulm, intygar härmed att nedan nämnda produkter överensstämmer med EU:s direktiv, EU:s säkerhetsstandard och produktspecifikation. Detta intyg upphör att gälla om produkten ändras utan vårt tillstånd.</p>	<p>Year of CE marking :          Date d'apposition du marquage CE :          Installatiejaar van de CE-aanduiding : <b>2007</b>          CE-Märkningsår :          CE-Märkningsår :          Год разрешения маркировки          знакомом CE :</p>
<p><b>DK EU Overensstemmelse certificat</b></p> <p>Undertegnede GARDENA International GmbH, Hans-Lorenser-Str. 40, D-89079 Ulm bekræfter hermed, at enheder listet herunder, ved afsendelse fra fabrikken, er i overensstemmelse med harmoniserede EU retningslinier, EU sikkerhedsstandarder og produktspecifikationsstandarder. Dette certifikat træder ud af kraft hvis enhederne er ændret uden vor godkendelse.</p>	<p>Ulm, 01.08.2007          Fait à Ulm, le 01.08.2007          Ulm, 01-08-2007          Ulm, 2007.08.01.          Ulm, 01.08.2007          Ульм, 01.08.2007</p> <p>Authorised representative          Représentant légal          Gemachtigde          Behörig Firmatecknare          Teknisk direktor          Уполномоченный представитель</p>
<p><b>RUS Свидетельство о соответствии ЕС</b></p> <p>Мы, нижеподписавшиеся GARDENA Manufacturing GmbH, Hans-Lorenser-Str. 40, D-89079 Ulm, настоящим подтверждаем, что нижеуказанное устройство, отгруженное с нашего предприятия, имеет исполнение, соответствующее требованиям согласованных директив ЕС, стандартам по технике безопасности ЕС и производственным стандартам. При несогласованном с нами изменении устройства настоящее свидетельство теряет силу.</p>	<p>          Peter Lameli          Vice President</p>

**Deutschland / Germany**

GARDENA  
Manufacturing GmbH  
Service Center  
Hans-Lorenser-Straße 40  
D-89079 Ulm  
Produktfragen:  
(+49) 731 490-123  
Reparaturen:  
(+49) 731 490-290  
service@gardena.com

**Argentina**

Argensem® S.A.  
Calle Colonia Japonesa s/n  
(1625) Loma Verde  
Escobar, Buenos Aires  
Phone: (+54) 34 88 49 40 40  
info@argensem.com.ar

**Australia**

Nylex Consumer Products  
50-70 Stanley Drive  
Somerton, Victoria, 3062  
Phone: (+61) 1800 658 276  
spare.parts@nylex.com.au

**Austria / Österreich**

GARDENA  
Österreich Ges.m.b.H.  
Stettnerweg 11-15  
2100 Korneuburg  
Tel.: (+43) 22 62 7 45 45 36  
kundendienst@gardena.at

**Belgium**

GARDENA Belgium NV/SA  
Sterrebeekstraat 163  
1930 Zaventem  
Phone: (+32) 2 7 20 92 12  
Mail: info@gardena.be

**Brazil**

Palash Comércio e  
Importação Ltda.  
Rua São João do Araguaia,  
338 – Jardim Califórnia –  
Barueri – SP – Brasil –  
CEP 06409-060  
Phone: (+55) 11 4198-9777  
eduardo@palash.com.br

**Bulgaria**

Хускварна България ЕООД  
1799 София  
Бул. „Андрей Ляпчев“ № 72  
Тел.: 02/ 8755148, 9753076  
www.husqvarna.bg

**Canada**

GARDENA Canada Ltd.  
100 Summerlea Road  
Brampton, Ontario L6T 4X3  
Phone: (+1) 905 792 9330  
info@gardenacanada.com

**Chile**

Antonio Martinic y Cia Ltda.  
Cassillas 272  
Centro de Cassillas  
Santiago de Chile  
Phone: (+56) 2 20 10 708  
garfar\_cl@yahoo.com

**Costa Rica**

Compania Exim  
Euroberoamericana S.A.  
Los Colegios, Moravia,  
200 metros al Sur del Colegio  
Saint Francis - San José  
Phone: (+506) 297 68 83  
exim\_euro@racsa.co.cr

**Croatia**

KLIS d.o.o.  
Stanciceva 79  
10419 Vukovina  
Phone: (+385) 1 622 777 0  
gardena@klis-trgovina.hr

**Cyprus**

FARMOKIPIKI LTD  
P.O. Box 7098  
74, Digeni Akritia Ave.  
1641 Nicosia  
Phone: (+357) 22 75 47 62  
condam@spidernet.com.cy

**Czech Republic**

GARDENA spol. s r.o.  
Tuřanka 115  
627 00 Brno  
Phone: (+420) 800 100 425  
gardena@gardenabrnno.cz

**Denmark**

GARDENA Norden AB  
Salgsafdeling Danmark  
Box 9003  
S-200 39 Malmö  
info@gardena.dk

**Finland**

Oy Husqvarna Ab  
Lautatarhankatu 8b/ PL 3  
FI-00581 HELSINKI

**France**

GARDENA  
PARIS NORD 2  
69, rue de la Belle Etoile  
BP 57080  
ROISSY EN FRANCE  
95948 ROISSY CDG CEDEX  
Tél. (+33) 0826 101 455  
service.consommateurs@  
gardena.fr

**Great Britain**

Husqvarna UK Ltd  
Preston Road  
Aycliffe Industrial Park  
Newton Aycliffe  
County Durham  
DL5 6UP  
info.gardena@husqvarna.co.uk

**Greece**

Agrokip  
Psomadopoulos S.A.  
Ifaistou 33A  
Industrial Area Koropi  
194 00 Athens Greece  
V.A.T. EL093474846  
Phone: (+30) 210 6620 225  
service@agrokip.gr

**Hungary**

GARDENA  
Magyarország Kft.  
Késmárk utca 22  
1158 Budapest  
Phone: (+36) 80 20 40 33  
gardena@gardena.hu

**Iceland**

Ó. Johnson & Kaaber  
Tunguhalsi 1  
110 Reykjavik  
ooj@ojk.is

**Ireland**

Michael McLoughlin & Sons  
Hardware Limited  
Long Mile Road  
Dublin 12

**Italy**

GARDENA Italia S.p.A.  
Via Donizetti 22  
20020 Lainate (Mi)  
Phone: (+39) 02.93.94.79.1  
info@gardenaitalia.it

**Japan**

KAKUICHI Co. Ltd.  
Sumitomo Realty &  
Development Kojimachi  
BLDG., 8F  
5-1 Nibanncyo, Chiyoda-ku  
Tokyo 102-0084  
Phone: (+81) 33 264 4721  
m\_ishihara@kaku-ichi.co.jp

**Luxembourg**

Magasins Jules Neuberg  
39, rue Jacques Stas  
Luxembourg-Gasperich 2549  
Case Postale No. 12  
Luxembourg 2010  
Phone: (+352) 40 14 01  
api@neuberg.lu

**Netherlands**

GARDENA Nederland B.V.  
Postbus 50176  
1305 AD ALMERE  
Phone: (+31) 36 521 00 00  
info@gardena.nl

**Neth. Antilles**

Jonka Enterprises N.V.  
Sta. Rosa Weg 196  
P.O. Box 8200, Curaçao  
Phone: (+599) 9 767 66 55  
pgm@jonka.com

**New Zealand**

NYLEX New Zealand Limited  
Building 2, 118 Savill Drive  
Mangere, Auckland  
Phone: (+64) 0800 22 00 88  
spare.parts@nylex.com.au

**Norway**

GARDENA Norden AB  
Salgskontor Norge  
Kleverveien 6  
1540 Vestby  
info@gardena.no

**Poland**

GARDENA Polska Sp. z o.o.  
Szymanów 9 d  
05-532 Baniocza  
Phone: (+48) 22 727 56 90  
gardena@gardena.pl

**Portugal**

GARDENA Portugal Lda.  
Sintra Business Park  
Edifício 1, Fração 0-G  
2710-089 Sintra  
Phone: (+351) 21 922 85 30  
info@gardena.pt

**Romania**

MADEX INTERNATIONAL SRL  
Soseaua Odaii 117-123,  
Sector 1,  
București, RO 013603  
Phone: (+40) 21 352 76 03  
madex@ines.ro

**Russia / Россия**

ООО ГАРДЕНА РУС  
123007, г. Москва  
Хорошевское шоссе, д. 32А  
Тел.: (+7) 495 540 99 57  
info@gardena-rus.ru

**Singapore**

Hy-Ray PRIVATE LIMITED  
40 Jalan Pemimpin  
#02-08 Tat Ann Building  
Singapore 577185  
Phone: (+65) 6253 2277  
hyray@singnet.com.sg

**Slovak Republic**

GARDENA Slovensko, s.r.o.  
Panónska cesta 17  
851 04 Bratislava  
Phone: (+421) 263 453 722  
info@gardena.sk

**Slovenia**

GARDENA d.o.o.  
Brodšče 15  
1236 Trzin  
Phone: (+386) 1 580 93 32  
servis@gardena.si

**South Africa**

GARDENA  
South Africa (Pty.) Ltd.  
P.O. Box 11534  
Vorna Valley 1686  
Phone: (+27) 11 315 02 23  
sales@gardena.co.za

**Spain**

GARDENA IBÉRICA S.L.U.  
C/ Basauri, nº 6  
La Florida  
28023 Madrid  
Phone: (+34) 91 708 05 00  
atencioncliente@gardena.es

**Sweden**

GARDENA Norden AB  
Försäljningskontor Sverige  
Box 9003  
200 39 Malmö  
info@gardena.se

**Switzerland / Schweiz**

GARDENA (Schweiz) AG  
Bitzberg 1  
8184 Bächenbülach  
Phone: (+41) 848 800 464  
info@gardena.ch

**Turkey**

GARDENA / Dost Diş Ticaret  
Mümesillik A.Ş. Sanayi  
Çad. Adil Sokak No. 1  
Kartal - İstanbul  
Phone: (+90) 216 38 93 939  
info@gardena-dost.com.tr

**Ukraine / Україна**

ALTSEST JSC  
4 Petropavlivska Street  
Petropavlivska  
Borschahivka Town  
Kyivo Svyatoshyyn Region  
08130, Ukraine  
Phone: (+380) 44 459 57 03  
uprr@altsest.kiev.ua

**USA**

Melnor Inc.  
3085 Shawnee Drive  
Winchester, VA 22604  
Phone: (+1) 540 722-9080  
service\_us@melnor.com

1862-28.960.02 / 0208  
© GARDENA  
Manufacturing GmbH  
D-89070 Ulm  
http://www.gardena.com