

Art. 1805

- E** **Manual de instrucciones**
Temporizador de riego T 1030
-
- P** **Instruções de utilização**
Relógio electrónico de Rega T 1030
-
- D** **Gebrauchsanweisung**
Bewässerungsuhr electronic T 1030
-
- GB** **Operating Instructions**
Water Timer Electronic T 1030
-
- PL** **Instrukcja obsługi**
Elektroniczny sterownik nawadniania
T 1030

Contenido
Conteúdo
Inhalt
Contents
Treść

Página
Página
Seite
Page
Strona

E

Resumen de las instrucciones para el uso
Manual de instrucciones
Garantía

6
4 - 17
74

P

Breves instruções de utilização
Instruções de utilização
Garantia

20
18 - 31
74

D

Kurz-Gebrauchsanweisung
Gebrauchsanweisung
Garantie

34
32 - 45
75

GB

Summary of Operating Instructions
Operating Instructions
Guarantee

48
46 - 58
75

PL

Skrócona instrukcja użytkownika
Instrukcja obsługi
Gwarancja

60
59 - 73
76

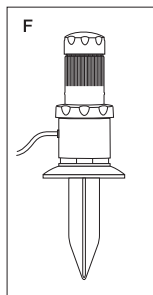
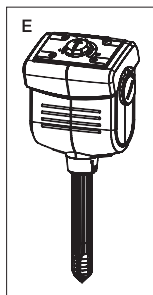
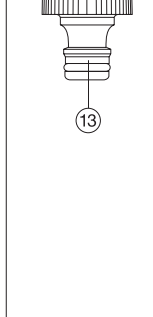
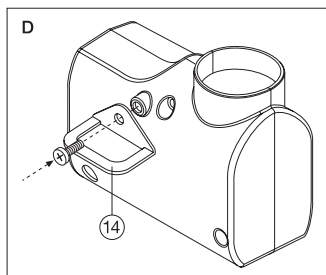
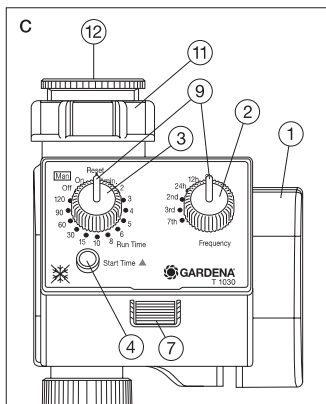
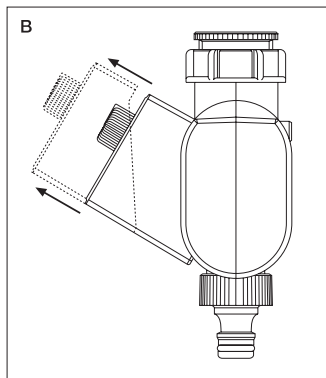
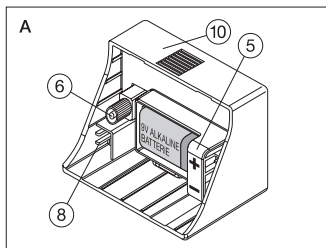

GARDENA

Water Timer Electronic T 1030



1. Notes on these Operating Instructions

Please read these operating instructions carefully and observe the notes given. Use these operating instructions to familiarise yourself with the water timer, the unit's features and proper use as well as with the notes on safety.

 **For safety reasons, children and young people under 16 as well as anyone who is not familiar with these operating instructions may not use the water timer.**

Keep these operating instructions in a safe place.

2. Proper Use

The GARDENA Water Timer Electronic T 1030 is suitable and determined for private use in domestic and hobby gardens, exclusively for outdoor use, to control sprinklers and watering systems.

 **The water timer must not be used for industrial purposes or in conjunction with chemicals, foodstuffs, easily flammable and explosive materials.**

Compliance with the operating instructions provided by the manufacturer is a prerequisite to ensure proper use of the GARDENA Water Timer Electronic.

The operating instructions also contain operating, servicing and maintenance conditions.

3. Technical Data

Operating impact pressure:	1 - 12 bar
Minimum flow rate:	20 l/h
Flow medium:	clean fresh water
Max. water temperature:	40 °C
Watering cycles per day (programmable):	up to 3
Watering cycles per week:	every day, every 2nd, 3rd or 7th day
Watering cycles per program:	1, 2, 3, 4, 5, 6, 8, 10, 15, 30, 60, 90 or 120 min.
Battery:	1 × 9 V alkali-manganese (alkaline) type IEC 6LR61
Service life of the battery:	approx. 1 year

4. How the Water Timer Electronic Works

This GARDENA Water Timer Electronic T 1030 allows you to set different watering times and cycles for different watering times independent of whether you are using a sprinkler, a sprinkler system installation or a drip-head watering system to water your garden.

Your Water Timer Electronic will water your garden completely automatically according to the program you choose. You can set the timer to water your garden early in the morning or late at night when water evaporates the least, or while you are on holiday.

5. Summary of Operating Instructions

1. Insert the battery.

Only use a 9 V alkali-manganese (alkaline) battery type IEC 6LR61. Check the polarity (+/- markings).

2. Setting the watering frequency

The following watering cycles can be selected using the **Frequency** control knob:

Setting	Watering Cycle
7 th	every 7 days
3 rd	every 3 days
2 nd	every 2 days
24 h	daily
12 h	twice a day
8 h	three times a day

3. Setting the watering time / starting time (Run Time)

You can select the watering time using the **Run Time** control knob ③. You can select 13 positions between 1 and 120 minutes.

The times you enter are accepted 5 seconds after you have finished entering the data. The time this happens is the future watering starting time.

4. Delaying the starting time (Start Time)

The Start Time can be delayed up to 5 seconds after you have selected the **Run Time**. Each time you press the **Start Time** ④, the Start Time is delayed by 1 hour from the original time set.

5. Manual On/Off operation (Man)

Turning the **Run Time** knob ③ to **On** opens the valve, turning it back to **Off** or to the required watering time, closes the valve. The starting time you originally programmed remains unchanged.

6. Reset

Turning the **Run Time** knob ③ to **Reset** deletes the starting time and watering time. The watering valve is not opened.

7. Bad weather operation (Man/Off)

If **Run Time** ③ is set to **Off**, your garden will not be watered automatically. e.g. during a rainy period. If, at the end of the rainy period, you turn the knob back to the required watering time, the starting time you selected remains unchanged.

6. Operating Parts

- ① Complete housing
- ② Watering cycle control knob
(Frequency)
- ③ Watering time control knob
(Run Time)
- ④ Key for starting time **(Start Time)**
- ⑤ Battery compartment
- ⑥ Control unit connection plug
- ⑦ Release button for control unit
- ⑧ Connection socket for Soil
Moisture Sensor / Rain Sensor
- ⑨ Control knob markings
- ⑩ Control unit
- ⑪ Sleeve nut

Accompanying accessories

- ⑫ G $\frac{3}{4}$ adaptor for sleeve nut
- ⑬ GARDENA threaded tap connector

Option

- ⑭ Anti-theft protection

7. Features of the Water Timer

7.1 Operating elements (Fig. C)

- | | |
|---------------------|---|
| Frequency | To set the watering cycle . |
| Run Time | To set the watering time (Run Time) , watering starting time and to open and close the water flow by hand. |
| Start Time ▲ | The starting time is delayed by an hour from the time you set the timer, each time you press the key. |

7.2 More Functions

Sleeve nut with adaptor

To connect the Water Timer to the tap.

GARDENA threaded tap connector

Fits GARDENA System hoses.

Connection

For GARDENA Soil Moisture Sensor (Art. No. 1188) and GARDENA Rain Sensor (Art. No. 1189).

Battery compartment

To insert a 9 V battery.

7.3 Other products which can be connected

- Fig. D **Anti-theft protection**
With special one-way screw and bracket.
Available from GARDENA Services.
- Fig. E GARDENA **Soil Moisture Sensor** (Art. No. 1188)
- Fig. F GARDENA **Rain Sensor** (Art. No. 1189)
- Fig. G GARDENA **Automatic Water Distributor** (Art. No. 1198)

8. Preparation for Use

Before you use your water timer you must:

1. Insert the battery
2. Connect the water timer to the tap
3. Ensure the new battery works properly.

8.1 Inserting the battery (Fig. A)

1. Remove the control unit ⑩ from the housing of the water timer by pressing the release button ⑦ (see Fig. B/C).
2. Insert the battery in the battery compartment ⑤ (only use a 9 V alkaline battery type IEC 6LR61) (Fig. A).
Note: When inserting the battery pay attention to the +/– markings.
3. Reattach the control unit to the housing.
The water timer beeps to signal it is ready to be programmed.
After another 5 seconds a double beep confirms that the current settings have been accepted (**except** when **Run Time** is set to **Reset**).
Note: the current time is taken to be the starting time.
4. To delete the current settings, turn the knob to **Reset**.
Set the timer as described under “Setting the Watering Data”.

8.2 Connecting to the Tap (Fig. C)

The Water Timer is fitted with a sleeve nut for taps with **33.3 mm (G1)** thread.

Adaptor for G ¾ thread (26.5 mm)

The adaptor supplied allows the Water Timer to be connected to taps with a G ¾ thread (26.5 mm). If you are using the adaptor, screw **the adaptor onto the tap** before screwing the water timer onto the adaptor.

Warning! Attach and screw on manually. Do not use pliers!

8.3 Checking the new battery

To check the new battery, turn on the tap and turn the knob on the water timer to **On** (valve opens) and then shortly afterwards to **Off** (valve closes). If the battery capacity is too low a warning tone which beeps at intervals will sound.

Note: To ensure that the water does not cause any damage make sure that the water flow is directed away from the water timer (connect hose, stand a bucket underneath, etc.).

9. Setting the Watering Data

Note: The control unit ⑩ of the water timer can be removed (Fig. B). This allows you to select the watering program somewhere other than where the water timer is to be used.

9.1 Setting the watering cycle

You can determine how often your garden should be watered by turning the **Frequency** knob ②:

- every 8, 12 or 24 hours (**8 h, 12 h, 24 h**) or
- every 2nd, 3rd or 7th day (**2nd, 3rd, 7th**)

Note: Intermediate positions are not possible.

9.2 Starting time and watering time

1. Turn the **Run Time** control knob ③ to **Reset**.
2. Then set the **Run Time** control knob ③ to the required watering time: **1, 2, 3, 4, 5, 6, 8, 10, 15, 30, 60, 90 or 120 minutes.**
Important! After 5 seconds the time you have set is accepted. This is signalled acoustically by a double beep.
3. The double beep also indicates that the current time has been accepted as the starting time for future watering programs. The **Start Time ▲** delayed by 1 hour from this original Start Time each time you press the key. The **Start Time ▲** must be activated before the double beep.
Note: The water timer beeps every time you press the key correctly to confirm you have delayed the time by one hour.

Important! Start Time ▲ is only active for a max. of 5 seconds after the last time you press the key. It is then no longer possible to change the starting time. This is signalled by a double beep.

The watering starting time can only be deleted by turning the knob to **Reset**.

9.3 Examples

Current time: 9:00 am.

The watering program should run as follows:

Example a) Every day at 9:00 for 10 minutes.

Example b) 3 x a day (= every 8 hours) for 2 minutes. at 10:00, at 18:00 and at 2:00.

Example c) Every 3 days at 16:00 for 60 minutes.

The timer should be programmed as follows:

	Step 1 Setting “Frequency”	Step 2 Setting “Run Time”	Step 3 “Start Time ▲” key
Example a)	24 h	10 min.	do not press
Example b)	8 h	2 min.	press once
Example c)	3 rd	60 min.	press 7 times

The watering time has now been changed. The water timer will now automatically run the required watering programs.

9.4 Turning off the watering programs

The watering programs can be switched off for any period of time e.g. in periods of bad weather as follows:

1. Turn the **Run Time** knob ③ clockwise to **Off**.
2. To restart the watering e.g. at the end of the bad weather period, turn the **Run Time** knob ③ back to the required watering time.

Note: The starting time you previously selected remains unchanged so that your garden is watered at the usual times (the times you programmed).

9.5 Manual On/Off operation

In addition to watering your garden fully automatically, the Water Timer can be operated manually by turning the **Run Time** knob ③ to **On** or **Off**. Automatic watering programs during this time are not executed or interrupted. After manually opening/closing the valve (**On/Off**) you can once again select a watering time. A watering starting time which you determined earlier remains unchanged.

“On” position

In the **On** position the valve is opened after a delay of 2 seconds and then automatically closed again after 30 minutes. If the water timer is switched to **On** during an automatic watering program the valve stays open and is closed after 30 minutes.

“Off” position

In the **Off** position, an open valve is closed after a delay of 2 seconds.

10. Changing the Setting

The time and the watering time can be changed using the control knob (**Run Time**).

The changes are accepted after approx. 5 seconds and this is signalled acoustically by a double beep. If the water timer is not reset the original starting time remains unchanged.

Making changes during watering

You can change the watering time (**Run Time**) during an automatic watering program as follows:

- If the elapsed watering time is **shorter** than the new watering time you have selected, then the new watering time is valid.

Example:

Old **Run Time** = 10 minutes, changed after 5 minutes to 30 minutes.
The total watering time is then 30 minutes.

- If the watering time which has already expired is **longer** than the new watering time, the water flow is interrupted in the next minute.

If you have already chosen the **starting time (Start Time / Run Time** already set) any changes you make to the watering frequency (**Frequency**) are active as soon as the next watering program starts.

If you have forgotten the current start time, you should reset the Water Timer and then re-enter the watering data.

11. Battery

11.1 Status indicator

If the battery capacity falls below a **certain level**, a warning signal sounds every 15 seconds. The programs you have set are not run. The water flow cannot be opened manually. If a valve is open, however, it will be closed.

11.2 Changing the battery

If the battery capacity is too low (the warning signal beeps every 15 seconds), you must change the battery. To do this, the water timer must be removed from the tap.

Important: Changing the battery deletes the data you have set.

To change the battery:

1. Insert the battery in the battery compartment ⑤.
2. Set the **Run Time** control knob ③ to **Reset**.
3. Reset the watering data as described in "Setting the watering data".

If the **Run Time** knob ③ is not turned to **Reset**, 5 seconds after the battery was inserted the current **Run Time** ③ and **Frequency** ② settings shall be accepted. This is confirmed by a double beep.

Note: The time the battery was changed is taken to be the starting time. To ensure that the water timer works properly we recommend that you insert a new battery at the beginning of every gardening season, or at the latest after a year.

Important! Please dispose of used batteries properly at the appropriate communal waste disposal site. Only dispose of batteries **when flat**.

12. Notes on Safety and Operation

- The minimum water output to ensure that the Water Timer functions correctly is 20 - 30 l/h.
For example, at least 10 x 2-litre Drip Heads are required to control the Micro-Drip-System.
- The Water Timer must be stored in a dry place away from frost before the frosty season begins.
- The max. temperature for the water flow is 40 °C.
- The minimum operating pressure is 1 bar, the maximum operating pressure is 12 bar.

- For functional safety reasons, only use a 9 V alkali-manganese battery.
- The water timer beeps at intervals to indicate that the battery capacity is too low until the battery is flat. When the water timer is beeping the valve is no longer opened. To ensure that the water timer works properly a battery with low capacity must be exchanged.
- We recommend fitting the water timer with a new battery at the beginning of every gardening season or at the latest after a year.
- The functional safety of the water timer depends on the capability of the battery. The water timer will only run for approx. 1 year if the new alkali-manganese battery has a nominal voltage of at least 9 V. Check the battery before you buy it.
- To prevent water penetrating the battery compartment, the Water Timer may only be installed in a perpendicular position with the sleeve nut pointing upwards.
- The control unit must be attached to the Water Timer during operation.
- **Warning!** Only use the water timer outdoors. The water timer is not approved for indoor use.
- Check the filter in the sleeve nut (ⓘ) regularly and clean if necessary.
- Avoid tensile strain. Do not pull the hose connected to the Water Timer.
- Only use clear fresh water.

13. Options

13.1 Anti-Theft Protection (Fig. F)

To protect your Water Timer against theft, the GARDENA anti-theft protection (1815-00.791.00) is available at GARDENA Service. The bracket on the anti-theft protection is fitted onto the back of the unit. Note that the screw included cannot be loosened once it has been screwed in. The bracket can be used, for example, to attach a chain.

13.2 GARDENA Soil Moisture Sensor (Fig. E)

Together with the GARDENA Soil Moisture Sensor Art. No. 1188 watering is controlled considering the soil moisture.

Assembly

The Soil Moisture Sensor is connected to the socket ⑧ on the back of the control unit (Fig. A).

How it works

If the connected Soil Moisture Sensor indicates there is sufficient moisture then the watering program is either interrupted or not initiated.

Note: Manual watering (**On, Off**) is still possible.

13.3 GARDENA Rain Sensor (Fig. F)

Together with the GARDENA Rain Sensor Art. No. 1189 watering is controlled considering natural precipitation.

Assembly

The Rain Sensor, as an alternative to the Soil Moisture Sensor, can be connected to the connection socket ⑧ on the back of the control unit (Fig. A).

How it works

If the connected Rain Sensor indicates an appropriate amount of rain, the watering program is interrupted or not initiated.

Note: Manual watering (**On, Off**) is still possible.

13.4 GARDENA Automatic Water Distributor (Fig. G)

Connecting the GARDENA Automatic Water Distributor (Art. No. 1198) allows you to control up to 6 watering lines with your water timer electronic (max. 3 lines per day).

Ideal in areas with not enough water flow to operate all areas at the same time. Allows the operation of each channel one after the other.

14. Faults

Faults	Possible cause	Remedy
Manual opening using “On” not / not completely possible.	Battery capacity too low.	Insert a new alkaline battery .
	Tap turned off.	Turn on tap.

Watering program do not run.	Battery capacity too low; water timer is beeping.	Insert a new alkaline battery .
	Watering program turned off. Run Time set to Off or Reset .	Set the Run Time to the required watering time.
	Valve was opened manually and closed automatically after 30 minutes. Run Time set to On .	Set the Run Time back to the required watering time.
	Tap turned off.	Turn on tap.
	Connected Soil Moisture / Rain Sensor indicates adequate amount of moisture.	Check the moisture level setting on the Soil Moisture / Rain Sensor.
Watering program run at the wrong time.	Water timer has been reset .	Determine the new starting time. Set the starting time (see "Setting the watering data").
Battery flat after working for a short time.	Not an alkaline battery.	Use an alkaline battery .
Device not working.	Battery inserted incorrectly.	Observe the +/- markings.
	Battery is flat.	Insert a new alkaline battery .

If you have any problems with your Water Timer, please contact our Customer Service.

Disposal (in accordance with RL2002/96/EC)



Device must not be added to normal household refuse but must be disposed of in the technically correct way.

We expressly point out that, in accordance with the product liability law, we are not liable for any damage caused by our units if it is due to improper repair or if parts exchanged are not original GARDENA parts or parts approved by us, and, if the repairs were not carried out by a GARDENA Service Centre or an authorised specialist. The same applies to spare parts and accessories.

EU Certificate of Conformity

The undersigned

GARDENA Manufacturing GmbH · Hans-Lorensen-Str. 40 · D-89079 Ulm

hereby certifies that, when leaving our factory, the unit indicated below is in accordance with the harmonised EU guidelines, EU standards of safety and product specific standards.

This certificate becomes void if the unit is modified without our approval.

Description of the unit:

Water Timer Electronic

Year of CE marking:

1998

Type: T 1030

Art. No.: 1805

Ulm, 17.07.1998

EU directives:

Electromagnetic Compatibility

89/336/EC

Directive 93/68/EC



Thomas Heinl

Technical Dept. Manager

D

Garantie

GARDENA gewährt für dieses Produkt 2 Jahre Garantie (ab Kaufdatum). Diese Garantieleistung bezieht sich auf alle wesentlichen Mängel des Gerätes, die nachweislich auf Material- oder Fabrikationsfehler zurückzuführen sind. Sie erfolgt durch die Ersatzlieferung eines einwandfreien Gerätes oder durch die kostenlose Reparatur des eingesandten Gerätes nach unserer Wahl, wenn folgende Voraussetzungen gewährleistet sind:

- Das Gerät wurde sachgemäß und laut den Empfehlungen in der Gebrauchsanweisung behandelt.
- Es wurde weder vom Käufer noch von einem Dritten versucht, das Gerät zu reparieren.

Defekte an der Bewässerungsuhr durch falsch eingelegte oder ausgelaufene Batterien sind von der Garantie ausgeschlossen.

Diese Hersteller-Garantie berührt die gegenüber dem Händler/Verkäufer bestehenden Gewährleistungsansprüche nicht.

Im Servicefall schicken Sie bitte das defekte Gerät zusammen mit einer Kopie des Kaufbelegs und einer Fehlerbeschreibung per Abhol-Service (nur in Deutschland) oder frankiert an die auf der Rückseite angegebene Serviceadresse. Nach erfolgter Reparatur senden wir das Gerät frei an Sie zurück.

GB

Guarantee

GARDENA guarantees this product for 2 years (from date of purchase). This guarantee covers all serious defects of the unit that can be proved to be material or manufacturing faults. Under warranty we will either replace the unit or repair it free of charge if the following conditions apply:

- The unit must have been handled properly and in keeping with the requirements of the operating instructions.
- Neither the purchaser or a non-authorised third party have attempted to repair the unit.

Defects in the Water Timer attributable to batteries which have been incorrectly installed or are leaking are excluded from the warranty provisions.

This manufacturer's guarantee does not affect the user's existing warranty claims against the dealer/seller.

If covered under warranty, please contact our Customer Service or return the defective unit together with a short description of the problem and a copy of the receipt directly to one of the GARDENA Service Centres listed on the back of this leaflet.

Deutschland / Germany

GARDENA
Manufacturing GmbH
Service Center
Hans-Lorenser-Straße 40
D-89079 Ulm
Produktfragen:
(+49) 7 31 490-123
Reparaturen:
(+49) 7 31 490-290
service@gardena.com

Argentina

Argensem® S.A.
Calle Colonia Japonesa s/n
(1625) Loma Verde
Escobar, Buenos Aires
Phone: (+54) 34 88 49 40 40
info@argensem.com.ar

Australia

Nylex Consumer Products
50-70 Stanley Drive
Somerton, Victoria, 3062
Phone: (+61) 1800 658 276
spare.parts@nylex.com.au

Austria / Österreich

GARDENA
Österreich Ges.m.b.H.
Stettnerweg 11-15
2100 Korneuburg
Tel.: (+43) 22 62 7 45 45 36
kundendienst@gardena.at

Belgium

GARDENA Belgium NV/SA
Sterrebeekstraat 163
1930 Zaventem
Phone: (+32) 2 720 92 12
Mail: info@gardena.be

Brazil

Palash Comércio e
Importação Ltda.
Rua Américo Brasiliense,
2414 - Chácara Sto Antonio
São Paulo - SP - Brasil -
CEP 04715-005
Phone: (+55) 11 5181-0909
eduardo@palash.com.br

Bulgaria

DENEX LTD.
2 Luis Ahalier Str. - 7th floor
Sofia 1404
Phone: (+359) 2 958 18 21
office@denex-bg.com

Canada

GARDENA Canada Ltd.
100 Summerlea Road
Brampton, Ontario
Canada L6T 4X3
Phone: (+1) 905 792 93 30
info@gardenacanada.com

Chile

Antonio Martinic y Cia Ltda.
Cassillas 272
Centro de Cassillas
Santiago de Chile
Phone: (+56) 2 20 10 708
garfar_cl@yahoo.com

Costa Rica

Compania Exim
Euroberoamericana S.A.
Los Colegios, Moravia,
200 metros al Sur del Colegio
Saint Francis - San José
Phone: (+506) 297 6883
exim_euro@racsa.co.cr

Croatia

KLIS d.o.o.
Stanciceva 79
10419 Vukovina
Phone: (+385) 1 622 777 0
gardena@klis-trgovina.hr

Cyprus

FARMOKIPIKI LTD
P.O. Box 7098
74, Digeni Akrita Ave.
CY-1641 Nicosia
Phone: (+357) 22 75 47 62
condam@spidernet.com.cy

Czech Republic

GARDENA spol. s r.o.
Řípská 20a, č.p. 1153
627 00 Brno
Phone: (+420) 800 100 425
gardena@gardenabrno.cz

Denmark

GARDENA Norden AB
Salgsafdeling Danmark
Box 9003
S-200 39 Malmö
info@gardena.dk

Finland

Habitec Oy
Martinkyläntie 52
01720 Vantaa

France

GARDENA
PARIS NORD 2
69, rue de la Belle Etoile
BP 57080
ROISSY EN FRANCE
95948 ROISSY CDG CEDEX
Tél. (+33) 0826 101 455
service.consommateurs@
gardena.fr

Great Britain

GARDENA UK Ltd.
27-28 Brenkley Way
Blezard Business Park
Seaton Burn
Newcastle upon Tyne
NE13 6DS
info@gardena.co.uk

Greece

Agrokop
Psomadopoulos S.A.
Ifaistou 33A
Industrial Area Koropi
194 00 Athens Greece
V.A.T. EL093474846
Phone: (+30) 210 66 20 225
service@agrokop.gr
www.agrokop.gr

Hungary

GARDENA
Magyarország Kft.
Késmárk utca 22
1158 Budapest
Phone: (+36) 80 20 40 33
gardena@gardena.hu

Iceland

Ó. Johnson & Kaaber
Tunguhalsi 1
110 Reykjavik
ooj@ojk.is

Ireland

Michael McLoughlin & Sons
Hardware Limited
Long Mile Road
Dublin 12

Italy

GARDENA Italia S.p.A.
Via Donizetti 22
20020 Lainate (Mi)
Phone: (+39) 02.93.94.79.1
info@gardenaitalia.it

Japan

KAKUICHI Co. Ltd.
Sumitomo Realty &
Development Kojimachi
BLDG., 8F
5-1 Nibanncoyo, Chiyoda-ku
Tokyo 102-0084
Phone: (+81) 33 264 4721
m_ishihara@kaku-ichi.co.jp

Luxembourg

Magasins Jules Neuberg
Grand Rue 30
Boîte postale 12
L-2010 Luxembourg
Phone: (+352) 40 14 01
info@neuberg.lu

Netherlands

GARDENA Nederland B.V.
Postbus 50176
1305 AD ALMERE
Phone: (+31) 36 521 00 00
info@gardena.nl

Neth. Antilles

Jonka Enterprises N.V.
Sta. Rosa Weg 196
P.O. Box 8200
Curaçao
Phone: (+599) 9 767 66 55
pgm@jonka.com

New Zealand

NYLEX New Zealand Limited
Building 2
118 Savill Drive
Mangere, Auckland
Phone: (+64) 9 270 1806
lena.chapman@nylex.com.au

Norway

GARDENA Norden AB
Salgskontor Norge
Karihaugveien 89
1086 Oslo
info@gardena.no

Poland

GARDENA Polska Sp. z o.o.
Szymanów 9 d
05-532 Baniocza
Phone: (+48) 22 727 56 90
gardena@gardena.pl

Portugal

GARDENA Portugal Lda.
Recta da Granja do Marquês
Edif. GARDENA Algueirão
2725-596 Mem Martins
Phone: (+351) 21 922 85 30
info@gardena.pt

Romania

MADEX INTERNATIONAL SRL
Soseaua Odaii 117-123
Sector 1,
București, RO 013603
Phone: (+40) 21 352 76 03
madex@ines.ro

Russia / Россия

ООО ГАРДЕНА РУС
123007, г. Москва
Хорошевское шоссе, д. 32А
Тел.: (+7) 495 247 25 10
info@gardena-rus.ru

Singapore

Hy - Ray PRIVATE LIMITED
40 Jalan Pemimpin
#02-08 Tat Ann Building
Singapore 577185
Phone: (+65) 6253 2277
hyray@singnet.com.sg

Slovak Republic

GARDENA Slovensko, s.r.o.
Panónska cesta 17
851 04 Bratislava
Phone: (+421) 263 453 722
info@gardena.sk

Slovenia

GARDENA d.o.o.
Brodišče 15
1236 Trzin
Phone: (+386) 1 580 93 32
servis@gardena.si

South Africa

GARDENA
South Africa (Pty.) Ltd.
P.O. Box 11534
Vorna Valley 1686
Phone: (+27) 11 315 02 23
sales@gardena.co.za

Spain

GARDENA IBÉRICA S.L.U.
C/ Basauri, nº 6
La Florida
28023 Madrid
Phone: (+34) 91 708 05 00
(4 líneas)
atencioncliente@gardena.es

Sweden

GARDENA Norden AB
Försäljningskontor Sverige
Box 9003
200 39 Malmö
info@gardena.se

Switzerland / Schweiz

GARDENA (Schweiz) AG
Bitziberg 1
8184 Bachenbülach
Phone: (+41) 848 800 464
info@gardena.ch

Turkey

GARDENA / Dost Diş Ticaret
Müessillik A.Ş. Sanayi
Çad. Adil Sokak No. 1
Kartal - İstanbul
Phone: (+90) 216 38 93 939
info@gardena-dost.com.tr

Ukraine / Украина

ALTSEST JSC
4 Petropavlivska Street
Petropavlivska
Borschahivka Town
Kyivo Svyatoshyn Region
08130, Ukraine
Phone: (+380) 44 459 57 03
upyr@altsest.kiev.ua

USA

Melnor Inc.
3085 Shawnee Drive
Winchester, VA 22604
Phone: (+1) 540 722-9080
service_us@melnor.com

1805-29.960.10/1206
© GARDENA
Manufacturing GmbH
D-89070 Ulm
http://www.gardena.com