

500 S
Art. 7644

1000 S
Art. 7645

D Betriebsanleitung
Wasserspielpumpen-Set

GB User's Manual
Fountain Pump Set

F Notice d'emploi
Pompe pour jets d'eau

NL Gebruiksaanwijzing
Waterspelpompset

S Manual
Pumpset för fontän

I Istruzioni per l'uso
Set pompa per giochi d'acqua

E Instrucciones de empleo
Conjunto de bombas de efectos acuáticos

P Manual de instruções
Conjunto para bombas de jogos de água

DK Driftsvejledning
Springvandspumpesæt

D

GB

F

NL

S

I

E

P

DK

GARDENA Fountain Pump Set 500 S / 1000 S

Welcome to the Garden of GARDENA ...



This is the translation of the original German User's Manual. Please read the User's Manual carefully and comply with them. Use this User's Manual to familiarise yourself with the pump, its proper use and the safety instructions.



For safety reasons, children under 16 as well as persons not familiar with this User's Manual must not use this pump.

→ Keep this User's Manual in a safe place.

Contents

1. Where to use your GARDENA Fountain Pump set	8
2. Safety instructions	8
3. Assembly	9
4. Initial Operation	10
5. Storing your Fountain Pump Set	10
6. Cleaning	10
7. Trouble-shooting	11
8. Accessories	11
9. Technical Data	12
10. Service / Guarantee	12

1. Where to use your GARDENA Fountain Pump set

Intended Use:

The GARDENA Fountain Pump is intended for domestic use. It is not designed for operating watering equipment and accessories or irrigation systems. The pump can be used both indoors and outdoors.

Please note



The GARDENA Fountain Pump is not suitable for continuous operation in industrial applications. Corrosive, easily combustible, aggressive or explosive substances (such as gasoline, petroleum or nitro thinners), or saltwater must not be pumped, nor must foodstuffs or drinking water.

2. Safety instructions

Electrical Safety:



DANGER ! Electric shock !

→ **Always disconnect the pump from the mains before undertaking any work on it.**

The pump should be operated via a residual current device with a residual current rating of ≤ 30 mA (DIN VDE 0100-702). The pump must be placed on solid, even ground.

→ Please ask your electrician for his advice. Mains power cables should not have a smaller cross-section than a rubber sheathed cable of the designation H05 RN-F3G0,75. Extension cables must meet the requirements of DIN VDE 0620. Check line voltage. Data indicated on the type plate must match technical data of the mains supply. Please unplug the pump after operation and before carrying out any maintenance works.

The pump must not be operated when there are people in the water.

Swimming pools and garden ponds should be designed according to international and national design regulations.

→ Please consult a professional electrician.

Before operating the pump, look to see if there is any damage to the pump (esp. regarding power cable and plug).

The connection cable of the pump cannot be replaced. If the cable is damaged the pump must be scrapped.

Do not use the power cable to carry the pump or to pull the plug out of the socket.

Protect the power cable from heat, oil and sharp edges.

User instructions:

Never let the pump run dry; running dry generates heat and will damage the pump.

The temperature of the liquid used must not be below 4 °C or above 35 °C.

Sand and other abrasive substances in the liquid cause increased wear and reduce the output of the pump.

Please observe the local noise prevention regulations.

3. Assembly

Fit the pump:

1. Screw the nozzle tube ② with side outlet into the socket ①.
2. Plug the nozzle tube ③ with regulating hole into the nozzle tube ②.
3. Plug further nozzle tube(s) ④ into the nozzle tube ③ as required.
4. Plug the fountain socket ⑤ into the top nozzle tube ④.
5. Insert the desired fountain insert into the fountain socket ⑤:

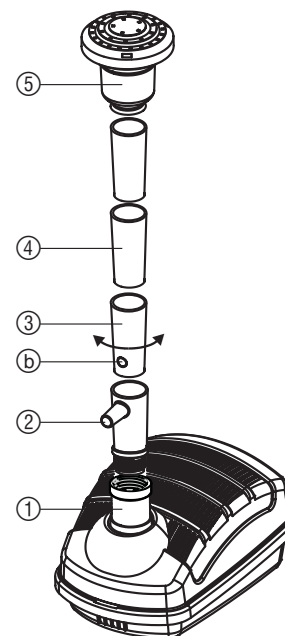

Setting the water feature patterns:

- a) Mount the cascade using the bayonet connection.
- b/c) Insert the water bell / jets of water into the water feature holder ⑤ as far as is **necessary** in order to set the **required size** of the water feature pattern.



a) cascade

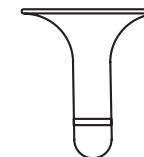

b) water bell

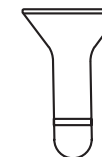

Only on the 1000 S
c) jets of water

Side outlet ②:

Other features (e. g. a gargoyle) can be connected to the side outlet of the nozzle tube ② [9 mm / 13 mm (1/2")].

→ The water quantity can be adjusted at the side outlet of the nozzle tube ② by adjusting the extent to which the regulating hole ⑥ of the nozzle tube ③ is covered by the side outlet ②.

4. Initial Operation

Switching the Fountain Pump on:

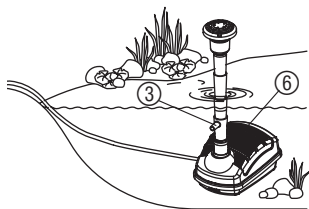

1. Place water feature pump on a firm base in such a way that the filter housing ⑥ is completely covered by water.
2. Plug mains plug into an AC power socket.
Warning: Pump will start immediately.
3. Use the nozzle tube regulating hole ③ to set the desired amount of water for the Fountain (see 3. Assembly "side outlet").

5. Storing your Fountain Pump Set

Storage:



The pump should be stored out of the reach of children.

1. Before the frosty season begins, take the pump out of the pond, clean it and store it in a frost-free place.
2. To avoid difficulties when starting up in the spring, we recommend storing the pump in a frost-free location in a container filled with water.
The mains plug must not be submerged.

Disposal:

(in accordance with
RL2002/96/EC)



The product must not be added to normal household waste. It must be disposed of properly.

6. Cleaning

Cleaning the fountain and filter housing:

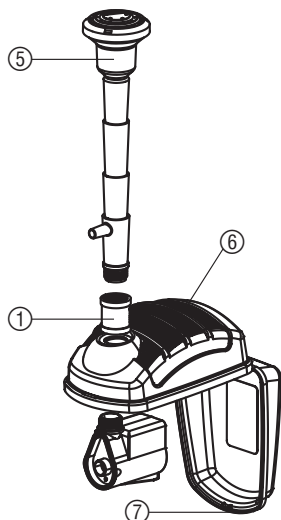

CAUTION! Electric shock !

Risk of injury due to mains electricity.

→ Before cleaning the pump, unplug the it from the mains.

1. Take the Fountain Pump out of the water.
2. Unscrew the nozzle tube and the socket ①.
3. Take the fountain insert out of the fountain socket ⑤.
4. Release the catches ⑦ and open the filter housing ⑥.
5. Remove the pump from the filter housing ⑥.
6. Clean the nozzle tube and fountain insert in clean water.
7. Clean the filter housing ⑥ with a water jet.
8. Reassemble the Fountain Pump in the reverse order.

7. Trouble-shooting



CAUTION! Electric shock!

Risk of injury due to mains electricity.

→ Before fault-finding, unplug the pump at the mains.

Cleaning the pump:

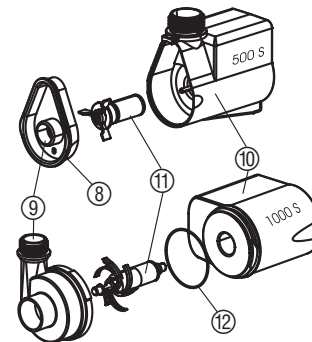

1. Remove the pump from the filter housing (see 6. Cleaning).
2. **500 S:** Release the catches ⑧ on the pump housing ⑨ and remove the pump housing ⑨.
1000 S: Turn the pump housing ⑨ anticlockwise and pull it vertically off the motor housing ⑩ (bayonet socket).
3. Pull impeller unit ⑪ out of the motor housing ⑩ and clean.
4. Push cleaned impeller unit ⑪ back into the motor housing ⑩.
5. **500 S:** Press the pump housing ⑨ on to the motor housing ⑩.
1000 S: Press the pump housing ⑨ vertically on to the motor housing ⑩ and tighten it clockwise. Make sure that the O-ring ⑫ is seated correctly.

Fault	Possible cause	Remedy
No water feature operating	Mains plug not plugged in.	→ Plug in mains plug.
	Impeller unit is blocked.	→ Clean pump.
Reduced water feature	Water feature insert is dirty.	→ Clean water feature insert and nozzle pipe.
	Filter housing dirty.	→ Clean filter housing.
	Open the side outlet.	→ Close the side outlet using the regulating hole.

CAUTION!



Work on the electrical parts must only be carried out by GARDENA Service Centres.

If any other faults arise, please contact GARDENA Service.

8. Accessories

GARDENA Underwater lights UL 20 / UL 35 / UL 20 S Set	Lighting the Fountain and the bank area.	art. 7952 art. 7954 art. 7958
GARDENA radio control set	Start water features and lighting from the terrace or your living room.	art. 7874

9. Technical Data

GB

	500 S (art. 7644)	1000 S (art. 7645)
Mains voltage / Frequency	230 V AC / 50 Hz	230 V AC / 50 Hz
Rated power	7 W	10 W
Power cable	10 m; H05-RN-F	10 m; H05-RN-F
Flow	500 l/h	1000 l/h
Max. delivery head	1,0 m	1,8 m
Max. submersion depth	1 m	1 m
Pump connection	G 1/2	G 1/2
Media temperature	4 °C – 35 °C	4 °C – 35 °C

10. Service / Guarantee

Guarantee

GARDENA guarantees this product for 3 years (from date of purchase). This guarantee covers all serious defects of the unit that can be proved to be material or manufacturing faults. Under warranty we will either replace the unit or repair it free of charge if the following conditions apply:

- The unit must have been handled properly and in keeping with the requirements of the operating instructions.
- Neither the purchaser or a non-authorized third party have attempted to repair the unit.

The feed impeller is a wearing part and is not covered by the warranty.

This manufacturer's guarantee does not affect the user's existing warranty claims against the dealer/ seller.

If you have any problems with your Fountain Pump Set, please contact our Service or return the defective unit together with a short description of the problem – in case of guarantee, with a copy of the receipt – postage paid to one of the GARDENA Service Centres listed on the back of this leaflet.

<p>D Produkthftung</p>	<p>Wir weisen ausdrücklich darauf hin, dass wir nach dem Produkthaftungsgesetz nicht für durch unsere Geräte hervorgerufene Schäden einzustehen haben, sofern diese durch unsachgemäße Reparatur verursacht oder bei einem Teileaustausch nicht unsere originale GARDENA Teile oder von uns freigegebene Teile verwendet wurden und die Reparatur nicht vom GARDENA Service oder dem autorisierten Fachmann durchgeführt wird. Entsprechendes gilt für Ergänzungsteile und Zubehör.</p>
<p>GB Product Liability</p>	<p>We expressly point out that, in accordance with the product liability law, we are not liable for any damage caused by our units if it is due to improper repair or if parts exchanged are not original GARDENA parts or parts approved by us, and, if the repairs were not carried out by a GARDENA Service Centre or an authorised specialist. The same applies to spare parts and accessories.</p>
<p>F Responsabilité</p>	<p>Nous vous signalons expressément que GARDENA n'est pas responsable des dommages causés par ses appareils, dans la mesure où ces dommages seraient causés suite à une réparation non conforme, dans la mesure où, lors d'un échange de pièces, les pièces d'origine GARDENA n'auraient pas été utilisées, ou si la réparation n'a pas été effectuée par le Service Après-Vente GARDENA ou l'un des Centres SAV agréés GARDENA. Ceci est également valable pour tout ajout de pièces et d'accessoires autres que ceux préconisés par GARDENA.</p>
<p>NL Productaansprakelijkheid</p>	<p>Wij wijzen er nadrukkelijk op, dat wij op grond van de wet aansprakelijkheid voor producten niet aansprakelijk zijn voor schade ontstaan door onze apparaten, indien deze door onvakkundige reparatie veroorzaakt zijn, of er bij het uitwisselen van onderdelen geen gebruik gemaakt werd van onze originele GARDENA onderdelen of door ons vrijgegeven onderdelen en de reparatie niet door de GARDENA technische dienst of de bevoegde vakman uitgevoerd werd. Ditzelfde geldt voor extra-onderdelen en accessoires.</p>
<p>S Produkansvar</p>	<p>Tillverkaren är inte ansvarig för skada som orsakats av produkten om skadan beror på att produkten har reparerats felaktigt eller om, vid reparation eller utbyte, andra än Original GARDENA reservdelar har använts. Samma sak gäller för kompletteringsdelar och tillbehör.</p>
<p>I Responsabilità del prodotto</p>	<p>Si rende espressamente noto che, conformemente alla legislazione sulla responsabilità del prodotto, non si risponde di danni causati da nostri articoli se originati da riparazioni eseguite non correttamente o da sostituzioni di parti effettuate con materiale non originale GARDENA o comunque da noi non approvato e, in ogni caso, qualora l'intervento non venga eseguito da un centro assistenza GARDENA o da personale specializzato autorizzato. Lo stesso vale per le parti complementari e gli accessori.</p>
<p>E Responsabilidad de productos</p>	<p>Advertimos que conforme a la ley de responsabilidad de productos no nos responsabilizamos de daños causados por nuestros aparatos, siempre y cuando dichos daños hayan sido originados por arreglos o reparaciones indebidas, por recambios con piezas que no sean piezas originales GARDENA o bien piezas no autorizadas por nosotros, así como en aquellos casos en que la reparación no haya sido efectuada por un Servicio Técnico GARDENA o por un técnico autorizado. Lo mismo es aplicable para las piezas complementarias y accesorios.</p>
<p>P Responsabilidade sobre o produto</p>	<p>Queremos salientar que segundo a lei da responsabilidade do fabricante, nós não nos responsabilizaremos por danos causados pelo nosso equipamento, quando estes ocorrerem em decorrência de reparações inadequadas ou da substituição de peças por peças não originais da GARDENA, ou peças não autorizadas. A responsabilidade tornar-se-á nula também depois de reparações realizadas por oficinas não autorizadas pela GARDENA. Esta restrição valerá também para peças adicionais e acessórios.</p>
<p>DK Produkansvar</p>	<p>Vi gør udtrykkeligt opmærksom på at i henhold til produktansvarsloven er vi ikke ansvarlige for skader forårsaget af vores udstyr, hvis det er på grund af uautoriserede reparationer eller hvis dele er skiftet ud og der ikke er anvendt originale GARDENA dele eller dele godkendt af os, eller hvis reparationerne ikke er udført af GARDENA-service eller en autoriseret fagmand. Det samme gælder for ekstra udstyr og tilbehør.</p>

<p>D EU-Konformitätserklärung Maschinenverordnung (9. GSGVO) / EMVG / Niedersp. RL Der Unterzeichnete GARDENA Manufacturing GmbH · Hans-Lorenser-Straße 40 · D-89079 Ulm bestätigt, dass die nachfolgend bezeichneten Geräte in der von uns in Verkehr gebrachten Ausführung die Anforderungen der harmonisierten EU-Richtlinien, EU-Sicherheitsstandards und produktspezifischen Standards erfüllen. Bei einer nicht mit uns abgestimmten Änderung der Geräte verliert diese Erklärung ihre Gültigkeit.</p>	Bezeichnung der Geräte: Wasserspielpumpen-Set Description of the units: Fountain Pump Set Désignation du matériel : Pompe pour jets d'eau Omschrijving van de apparaten: Waterspelpompset Produktbeskrivning: Pumpset för fontän Descrizione dei prodotti: Set pompa per giochi d'acqua
<p>GB EU Certificate of Conformity The undersigned GARDENA Manufacturing GmbH · Hans-Lorenser-Str. 40 · D-89079 Ulm hereby certifies that, when leaving our factory, the units indicated below are in accordance with the harmonised EU guidelines, EU standards of safety and product specific standards. This certificate becomes void if the units are modified without our approval.</p>	Descripción de la mercancía: Conjunto de bombas de efectos acuáticos Descrição dos aparelhos: Conjunto para bombas de jogos de água Beskrivelse af produktet: Springvandspumpesæt
<p>F Certificat de conformité aux directives européennes Le constructeur, soussigné : GARDENA Manufacturing GmbH · Hans-Lorenser-Str. 40 · D-89079 Ulm déclare qu'à la sortie de ses usines le matériel neuf désigné ci-dessous était conforme aux prescriptions des directives européennes énoncées ci-après et conforme aux règles de sécurité et autres règles qui lui sont applicables dans le cadre de l'Union européenne. Toute modification portée sur ce produit sans l'accord express de GARDENA supprime la validité de ce certificat.</p>	Typen: Art.-Nr.: Types: Art. No.: Types : Référence : Type: Art.nr.: Typ: Art.nr.: Tipi: Art.: Tipos: Art. No.: Tipos: Art. no.: Typer: Art. nr.:
<p>NL EU-overeenstemmingsverklaring Ondergetekende GARDENA Manufacturing GmbH · Hans-Lorenser-Str. 40 · D-89079 Ulm bevestigt, dat de volgende genoemde apparaten in de door ons in de handel gebrachte uitvoering voldoen aan de eis van, en in overeenstemming zijn met de EU-richtlijnen, de EU-veiligheidsstandaard en de voor het product specifieke standaard. Bij een niet met ons afgestemde verandering aan de apparaten verliest deze verklaring haar geldigheid.</p>	<div style="display: flex; justify-content: space-around;"> <div style="text-align: center;">500 S 1000 S</div> <div style="text-align: center;">7644 7645</div> </div>
<p>S EU Tillverkarintyg Undertecknad firma GARDENA Manufacturing GmbH · Hans-Lorenser-Str. 40 · D-89079 Ulm intygar härmed att nedan nämnda produkter överensstämmer med EU:s direktiv, EU:s säkerhetsstandard och produktspecifikation. Detta intyg upphör att gälla om produkten ändras utan vårt tillstånd.</p>	EU-Richtlinien: EU directives: Directives européennes : EU-richtlijnen: EU directive: Directive UE: Normativa UE: Directrizes da UE: EU Retningslinier: 98/37/EG: 1998 2006/42/EG: 2006 2004/108/EG 2006/95/EG 93/68/EG
<p>I Dichiarazione di conformità alle norme UE La sottoscritta GARDENA Manufacturing GmbH · Hans-Lorenser-Str. 40 · D-89079 Ulm certifica che il prodotto qui di seguito indicato, nei modelli da noi commercializzati, è conforme alle direttive armonizzate UE nonché agli standard di sicurezza e agli standard specifici di prodotto. Qualunque modifica apportata al prodotto senza nostra specifica autorizzazione invalida la presente dichiarazione.</p>	Anbringningsjahr der CE-Kennzeichnung: Year of CE marking: Date d'apposition du marquage CE : Installatiejaar van de CE-aanduiding: Märkningsår: Anno di applicazione della certificazione CE: Colocación del distintivo CE: Ano de marcação pela CE: CE-Märkningsår: 2005
<p>E Declaración de conformidad de la UE El que suscribe GARDENA Manufacturing GmbH · Hans-Lorenser-Str. 40 · D-89079 Ulm declara que la presente mercancía, objeto de la presente declaración, cumple con todas las normas de la UE, en lo que a normas técnicas, de homologación y de seguridad se refiere. En caso de realizar cualquier modificación en la presente mercancía sin nuestra previa autorización, esta declaración pierde su validez.</p>	
<p>P Certificado de conformidade da UE Os abaixo mencionados GARDENA Manufacturing GmbH · Hans-Lorenser-Str. 40 · D-89079 Ulm Por este meio certificam que ao sair da fábrica os aparelhos abaixo mencionados estão de acordo com as directrizes harmonizadas da UE, padrões de segurança e de produtos específicos. Este certificado ficará nulo se as unidades forem modificadas sem a nossa aprovação.</p>	<div style="text-align: center;">  Peter Lameli Technische Leitung Technical Dept. Manager Direction technique Hoofd technische dienst Technical Director Direzione Tecnica Dirección Técnica Director Técnico Teknisk direktør </div>
<p>DK EU Overensstemmelse certificat Undertegnede GARDENA Manufacturing GmbH · Hans-Lorenser-Str. 40 · D-89079 Ulm bekræfter hermed, at enheder listet herunder, ved afsendelse fra fabrikken, er i overensstemmelse med harmoniserede EU retningslinier, EU sikkerheds standarder og produkt specifikations standarder. Dette certifikat træder ud af kraft hvis enhederne er ændret uden vor godkendelse.</p>	

500 S: Art. 7644
Pumpen-Kennlinie
Performance characteristics
Courbes de performance
Prestatiegrafiek
Kapacitetskurva
Curva di rendimento
Curva característica de la bomba
Características de performance
Ydelses karakteristika

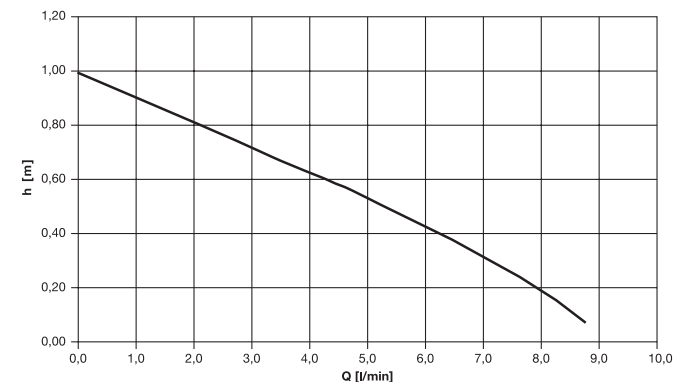

1000 S: Art. 7645
Pumpen-Kennlinie
Performance characteristics
Courbes de performance
Prestatiegrafiek
Kapacitetskurva
Curva di rendimento
Curva característica de la bomba
Características de performance
Ydelses karakteristika

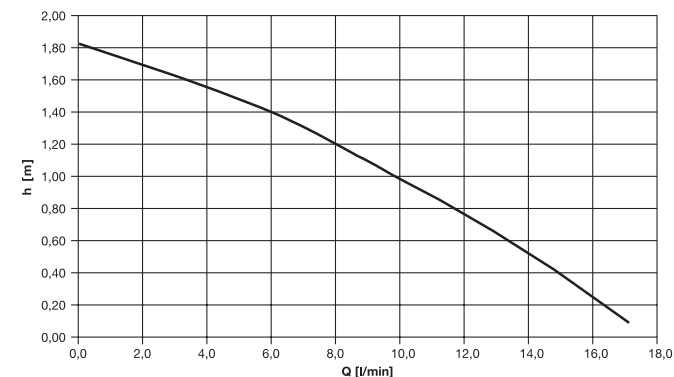

Deutschland / Germany

GARDENA
Manufacturing GmbH
Service Center
Hans-Lorenser-Str. 40
89079 Ulm
Produktfragen:
(+49) 731 490-123
Reparaturen:
(+49) 731 490-290
service@gardena.com

Argentina

Argensem de Comercializa-
dora Mecafron S. A.
Casilla de Correo 193
(1625) Escobar, Pcia. de
Buenos Aires
Phone: (+54) 34 88 49 40 40
info@argensem.com.ar

Australia

NYLEX Consumer Products
50 – 70 Stanley Drive
Somerton, Victoria, 3062
Phone: 1800 658 276
spare.parts@nylex.com.au

Austria / Österreich

GARDENA Österreich
Ges. m.b.H.
Stettnerweg 11-15
2100 Korneuburg
Tel.: (+43) 22 62 745 45-36
od. -30
kundendienst@gardena.at

Belgium

GARDENA Belgium NV/SA
Sterrebeekstraat 163
1930 Zaventem
Phone: (+32) 27 20 921 2
info@gardena.be

Brazil

Palash Importação
e Comércio Ltda
Rua Américo Brasiliense
2414 – Chácara Sto. Antonio
São Paulo – SP –
CEP 04715-005, Brazil
Phone: (+55) 11 5181-20 20
eduardo@palash.com.br

Bulgaria

DENEX LTD.
2 Luis Ahalier Str., 7th floor
Sofia 1404
Phone: (+359) 2 9581821
office@denex-bg.com

Canada

GARDENA Canada Ltd.
100 Summerlea Road
Brampton, Ontario L6T 4X3
Phone: (+1) 905 792 93 30
info@gardenacanada.com

Chile

Garden Chile S.A.
San Sebastián 2839
Ofic. 701 A
Las Condes - Santiago de Chile
Phone: (+56) 2 20 10 708
garfar_cl@yahoo.com

Costa Rica

Compañía Exim
Euroiberoamericana S.A.
Apto Postal 1260
San José
Phone: (+506) 223 20 75
exim_euro@racsa.co.cr

Croatia

KLIS d.o.o.
Stancičeva 79
10419 Vukovina
Phone: (+385) 1 622 777 0
gardena@klis-trgovina.hr

Cyprus

FARMOKIPIKI LTD
P.O. Box 7098
74, Digeni Akrita Ave.
1641 Nicosia
Phone: (+357) 22 75 47 62
condam@spidernet.com.cy

Czech Republic

GARDENA spol. s.r.o.
Řipská 20a, č.p. 1153
62700 Brno
Phone: (+420) 800 100 425
(Hotline)
gardena@gardenabrno.cz

Denmark

GARDENA Norden AB
Sales Office Denmark
Box 9003
S-200 39 MALMÖ
info@gardena.dk

Finland

Habitec Oy
Tiilitie 14
01720 Vantaa

France

GARDENA France
PARIS NORD 2
69, rue de la Belle Etoile
BP 57080 ROISSY EN FRANCE
95948 ROISSY CDG CEDEX
Tél. : (+33) 0826 101 455
service.consommateurs@
gardena.fr

Great Britain

GARDENA UK Ltd.
27/28 Brenkley Way
Bleazard Business Park
Seaton Burn
Newcastle upon Tyne
NE13 6DS
info@gardena.co.uk

Greece

Agrokip-Psomadopoulos S. A.
33 A, Ifestou str.
Industrial Area
194 00 Koropi, Athens
Phone: (+30) 210 66 20-2 25
and -2 26
service@agrokip.gr

Hungary

GARDENA Magyarország Kft.
Késmárk utca 22
1158 Budapest
Phone: (+36) 80 20 40 33
(Hotline)
gardena@gardena.hu

Iceland

Ó. Johnson & Kaaber
Tunguhalsi 1
110 Reykjavik

Ireland

McLoughlin's Ltd.
Unit 5
Norther Cross Business Park
North Road, Finglas
Dublin 11

Italy

GARDENA Italia S.p.A.
Via Donizetti 22
20020 Lainate (Mi)
Phone: (+39) 02.93.94.79.1
info@gardenaitalia.it

Japan

KAKUICHI co., Ltd.
Sumitomo Realty & Develop-
ment Kojimachi
BLDG., 8F
5 – 1 Nibanncyo, chiyoda-ku,
Tokyo 102-0084
Phone: (+81)-(0)3-3264-4721
m_ishihara@kaku-ichi.co.jp

Luxembourg

Magasins Jules Neuberg
39, rue Jacques Stas
Luxembourg-Gasperich 2549
Case Postale No. 12
Luxembourg 2010
Phone: (+352) - 40 14 01
api@neuberg.lu

Netherlands

GARDENA Nederland B.V.
Postbus 50176
1305 AD ALMERE
Phone: (+31) 36 521 00 00
info@gardena.nl

Neth. Antilles

Jonka Enterprises N.V.
Sta. Rosa Weg 196
P.O. Box 8200
Curaçao
Phone: (+599) 9 767 66 55
pgm@jonka.com

New Zealand

NYLEX New Zealand Ltd.
Building 2
118 Savill Drive
Mangere, Auckland
Phone: +64 9 270 1806
lena.chapman@nylex.com.au

Norway

GARDENA Norden AB
Sales Office Norway
Karihaugveien 89
1089 OSLO

Poland

GARDENA Polska Sp. z o.o.
Szymanów 9d
05-532 Baniocha
Phone: (+48) 22 727 56 90
gardena@gardena.pl

Portugal

GARDENA Portugal Lda.
Edif. GARDENA
Algueirão
2725-596 Mem Martins
Phone: 219228530
info@gardena.pt

Romania

MADEX INTERNATIONAL SRL
Șoseaua Odăii 117 – 123
Sector 1, București,
RO 013603
Phone: (+40) 21 352-7603 /
4 / 5 / 6
madex@gardena.ro

Russia / Россия

ООО «ГАРДЕНА РУС»
Хорошевское шоссе, д. 32А
123 007 г. Москва
Phone: +7 (495) 647-25-10

Singapore

HY-RAY PRIVATE LIMITED
40 JALAN PEMIMPIN
#02-08 Tat Ann Building
Singapore 577185
Phone: (+65) 625 32 277
hyray@singnet.com.sg

Serbia

DOMEL d.o.o.
Savski Nasip 7
11070 Novi Beograd
Serbia
Phone: (+381) 11 2772 204
miroslav.jejina@domel.co.yu

Slovenia

GARDENA d.o.o.
Brodišče 15
1236 Trzin
Phone: (+386) 1 580 93 32
servis@gardena.si

South Africa

GARDENA
South Africa (Pty.) Ltd.
P.O. Box 11534
Vorna Valley 1686
Phone: (+27) 11 315 02 23
sales@gardena.co.za

Spain

GARDENA IBÉRICA S.L.U.
C/Basauri, nº 6
La Florida
28023 Madrid
Phone: (+34) 91 708 05 00
(4 líneas)
atencioncliente@gardena.es

Sweden

GARDENA Norden AB
Försäljningskontor Sverige
Box 9003
20039 Malmö
info@gardena.se

Switzerland / Schweiz

GARDENA (Schweiz) AG
Brüelstrasse 4
8157 Dielsdorf
Tel.: 01/860 26 66
info@gardena.ch

Turkey

GARDENA Dost Dış Ticaret
Mümesillik A.Ş.
Sanayi Çad. Adil Sok. No. 1
34873 Kartal – Istanbul
Phone: (+90) 216 38 93 939
info@gardena-dost.com.tr

Ukraine / Україна

Altsest JSC
4 Petropavlivska Street
Petropavlivska Borschahivka
Town
08130 Kyivo Svyatoshyn Regi-
on
Phone: +380 44 4595703
info@gardena.ua

USA

GARDENA
Melnor, 3085 Shawnee Drive
Winchester, VA 22601
Phone: (5 40) 7 22-90 80
service_us@melnor.com

7644-20.960.02/0407
© GARDENA Manufacturing GmbH
D-89070 Ulm
http://www.gardena.com