

SR 2000 Art. 7947

- D** **Gebrauchsanweisung**
Teichschlammsauger
-
- GB** **Operating Instructions**
Pond Silt Remover
-
- F** **Mode d'emploi**
Aspirateur de bassin
-
- NL** **Gebruiksaanwijzing**
Vijvervuilzuiger
-
- S** **Bruksanvisning**
Slamsugare för damm
-
- I** **Istruzioni per l'uso**
Pulitore per laghetti
-
- E** **Manual de instrucciones**
Aspirador de fango para estanque
-
- P** **Instruções de utilização**
Aspirador de lodo de lago
-
- DK** **Brugsanvisning**
Bassinstøvsuger

GARDENA Pond Silt Remover SR 2000

Welcome to the Garden with GARDENA...



Please read these operating instructions carefully and observe the notes given. Use these operating instructions to familiarise yourself with the Pond Silt Remover, its proper use and the notes on safety.



For safety reasons, children under the age of 16 and people who have not read these operating instructions must not use this Pond Silt Remover.

→ Please keep these operating instructions in a safe place.

Contents

1. Where to Use Your GARDENA Pond Silt Remover	10
2. Safety instructions	10
3. Function	11
4. Assembly	12
5. Operation	13
6. Storage	14
7. Maintenance	14
8. Troubleshooting	14
9. Technical data	16
10. Service / Warranty	16

1. Where to Use Your GARDENA Pond Silt Remover

Correct use:

As a Pond Silt Remover: The Pond Silt Remover is suitable for the removal of particles of dirt up to 20 mm, thread algae, leaves and silt from garden ponds, and for removal of large particles of dirt from swimming pools.

As a Wet Suction Pump: The Pond Silt Remover is suitable for suction of dirty water with particles of dirt up to 20 mm.

Please note



The GARDENA Pond Silt Remover is not suitable for continuous operation (e.g. industrial applications, continuous pumping operations). It should not be used as a dry suction pump.

2. Safety instructions



DANGER! Risk of explosion!

Never use the equipment in the vicinity of explosive liquids or vapours. The equipment is not protected for use in explosive environments.

The Pond Silt Remover must not be used for suction of flammable or poisonous materials (such as petrol, asbestos, asbestos dust, copier toner) or volatile substances, acids, hot or glowing ashes, dust, sand or similar dry dirty materials.

Electrical safety:



DANGER! Electric shock!

Do not operate the equipment if there are people or animals in the pond or suction area.

Before reaching into the water, always unplug the mains plugs of all equipment in the water.

Compare the mains electrical power supply with the information on the packaging / on the model plate on the equipment.

Make sure that the equipment is supplied through a residual current protection device measuring a residual current of 30 mA or less.

Only connect the equipment to a properly installed socket outlet.

Keep the mains plug and all connection points dry!

Do not use the equipment in the rain or leave it out in the rain.

Lay the connection cable so that it is protected and cannot be damaged.

Only use cables that are suitable for outdoor use.

Never lift or carry the equipment by the connection cable!

Do not use the equipment if the cable or housing is defective!

If the connection cable is damaged this must be replaced by GARDENA Service.

Electrical installations at garden ponds must satisfy the applicable national and international installation regulations.

Never open the housing of the equipment or its associated parts unless you are expressly instructed so to do in the Operating Instructions.

If you have questions or encounter problems, for your own safety refer to a qualified electrician!

Operation:

When working by a pond always ensure the equipment is securely mounted.

Do not apply sustained tension to the hoses.

Avoid drawing in bulky dirt particles – they could block the suction or discharge hose and the valves inside the filter tray.

Never make any technical modifications to the equipment.

Always use original spare parts and accessories for the equipment.

Repairs must only be carried out by GARDENA Service centres.

The Pond Silt Remover must always have its foam filter in place when in use.

The foam filter is only suitable for liquids. When in use as a wet suction pump do not suck up any dry dust or – this can lead to damage.

3. Function

Automatic continuous operation without interruption of operation:

The pond silt remover draws the pond water into one chamber of the filter tray ③ via the adapter nozzle ① and the suction tube ②.

At the same time, the pond silt remover drains the dirty water into the other chamber of the filter tray again via the drain hose ④.

Circulation system:

The water flows back into the pond through the fine filter bag ⑤. This means no pond water is lost, and the biological equilibrium of the pond is maintained.

The water that is fed back contains biologically active floating particles. The resulting turbidity of the pond can last several days.

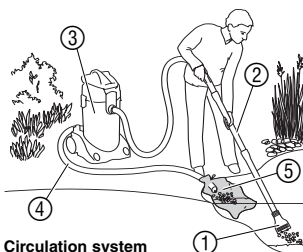

The end of the drain hose must not be underwater!

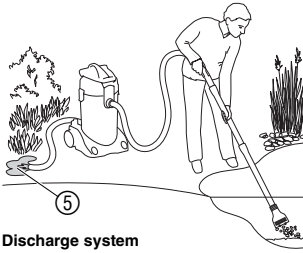

Discharge system

Discharge system:

The pond water that is sucked out is discharged into the environment. The fine filter bag ⑤ can also be used for this.

Fine filter bag:

The particles of dirt and pond silt that are collected in the fine filter bag ⑤ can be used as fertiliser or disposed of in the compost.

Applications of the various adapter nozzles**Bottom nozzle**

For sucking pond silt up from the bottom of the pond.

The bottom nozzle can be adjusted to suit the conditions at the bottom of the pond:

- Bottom nozzle fully open (10 mm): use on pond liners (no pebbles on the bottom, thick layer of silt).
- Bottom nozzle closed (2 mm): use on pond liners (pebbles as bottom covering, thick layer of silt).

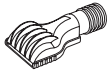

For optimum suction in rigid pond liners and of thin layers of silt, turn the bottom nozzle through 180°.

Joints nozzle

For sucking from narrow spaces, such as between stones and plants.

Thread algae nozzle

For sucking up thread algae.

Brush nozzle

For removing stubborn dirt.

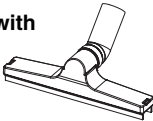
Wide nozzle with rubber lip

For sucking up residual water e.g. on terraces, in garages, cellar etc.

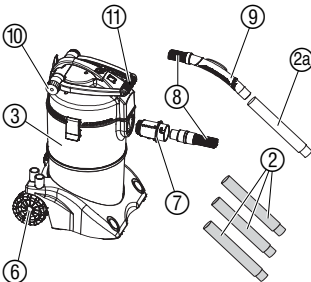
4. Assembly**Pond Silt Remover / Wet Suction Pump:**

1. Insert the wheels ⑥ into the pond silt remover until they engage.
2. Insert intake distributor ⑦ into the upper suction opening of the filter tray ③ (bayonet fitting). Comply with arrow marking.
3. Insert end piece of the suction hose ⑧ into the intake distributor ⑦.
4. Push transparent suction tube ②a on to the handle ⑨.
5. Push on black suction tubes ② as required.

Carrying Position of the curved handle:

→ Release the fixing screw ⑩, move the carrying handle ⑪ to the position required and tighten the fixing screw again ⑩.

5. Operation

Operation as a Pond Silt Remover:

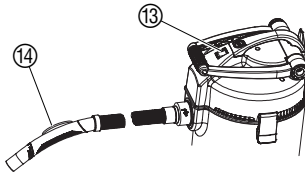
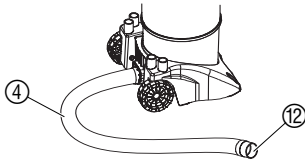
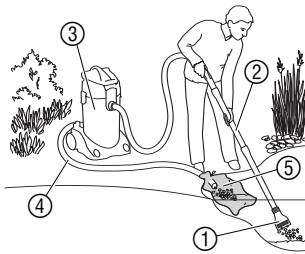

The higher the filter tray ③ above the surface of the water, the less the suction power.

1. Set up the filter tray ③ at least 2 m away from the edge of the pond, between 0.15 - 0.5 m above the water level so that is stable and will not overflow.
2. Insert the discharge hose ④ into the discharge opening of the catchment tank ③.
3. Lay the discharge hose ④ on ground with a falling gradient, so that the hose is self-draining.
4. If required, draw the fine filter bag ⑤ over the end of the discharge hose ④ (see 3. Function) and close with the cord.
5. Attach the desired nozzle ① (see 3. Function) to the suction tube ②.
6. Insert the Pond Silt Remover mains plug into a power socket.
7. Set the ON switch ⑬ to position I.

The pond silt remover draws the pond water in and simultaneously discharges the dirty water via the discharge hose.

8. Guide the nozzle ① on to the bottom of the pond. Then suck up the dirt with slow and even movements.
9. Regulate the suction power via the slide ⑭ on the handle if necessary.

Operation as Wet Suction Pump:

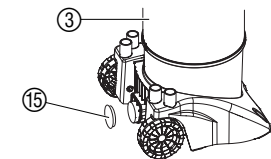

1. Insert stopper plug ⑮ in the lower discharge opening of the filter tray ③.
2. Attach the wide nozzle ① (see 3. Function) to the suction tube ②.
3. Insert the Pond Silt Remover mains plug into a power socket.
4. Set the ON switch ⑬ to position II.

The pond silt remover draws in the water until both chambers are full.

5. Regulate the suction power via the slide ⑭ on the handle if necessary.
6. If suction has ceased, the filter trays ③ are full. Then set the On-switch ⑬ to position 0 (OFF).
7. At the chosen discharge location remove the stopper plug ⑮ and empty the filter tray ③.

Development of Mist During Operation:

Heated, moist air, which is drawn in by the turbine, can lead to mist developing. This is normal (especially if it is cold) and does not indicate a fault.

6. Storage

Storage:



Store out of the reach of children.

→ Clean the Pond Silt Remover (see 7. Maintenance) and store in a frost-free place.

The pond silt remover is not frost-proof.

Disposal:

(in accordance with
RL2002/96/EC)



The product must not be added to normal household waste. It must be disposed of in line with local environmental regulations.

7. Maintenance

Pond Silt Remover cleaning:



DANGER! Electric shock!

→ Before maintenance work, unplug the cable at the mains.

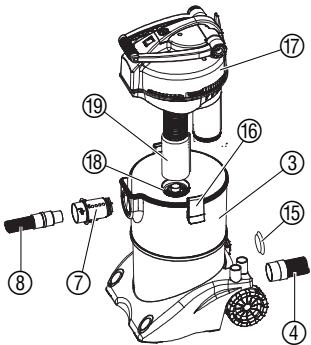

1. Draw suction hose ⑧, discharge hose ④ / sealing plug ⑮ and intake distributor ⑦ (bayonet fitting) out of the filter tray ③ and clean with pure water.
2. Release container locks ⑯ and remove the motor housing ⑰.
3. Remove retaining plates ⑱ (bayonet fitting) and pieces of filter foam ⑲ from the motor housing ⑰.
4. Flush out the filter tray ③ and pieces of filter foam ⑲ with pure water. Replace pieces of filter foam ⑲ if necessary.
5. Check float switch ⑳ for ease of movement.
6. Reassemble pond silt remover in reverse order.

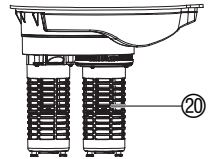

8. Troubleshooting



DANGER! Electric shock!

→ Disconnect the Pond Silt Remover at the mains before rectifying any faults.

Fault	Possible Cause	Remedy
The pond silt remover does not draw or the suction power drops	Pond silt remover too high above the level of the water.	→ Set up pond silt remover max 0.5 m above the level of the water.
	Filter foam, suction tube, suction hose or intake distributor dirty.	→ Clean pond silt remover (see 7. Maintenance).
	Valve rubber of the intake distributor is leaking / stuck.	→ Clean valve rubber or replace if necessary (see below).
	Sealing rings are not correctly seated or are damaged.	→ Check all the sealing rings and replace if necessary (see below).

Fault	Possible Cause	Remedy
The filter trays do not empty completely	The discharge hose has been kinked or is laid too flat.	→ Remove the kink or lay discharge hose with a steeper gradient.
	Fine filter bag is full.	→ Empty fine filter bag.
	Filter tray is set up < 0.15 m above the surface of the pond.	→ Set up filter tray in a higher position.
	Both containers are full of water.	→ Switch off pond silt remover (the pond silt remover will switch itself off automatically).
	The end of the discharge hose is in the water.	→ Take the end of the discharge hose out of the water.
The pond silt remover switches on and off irregularly	Discharge or discharge hose dirty.	→ Clean discharge and discharge those.
	Intake distributor or valve rubber dirty or sealing ring leaking.	→ Clean intake valve and replace the sealing ring / valve rubber if necessary.

Replace sealing rings and valve rubbers:

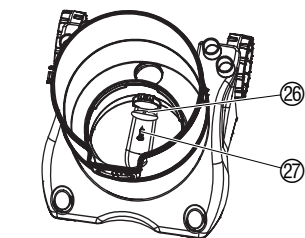
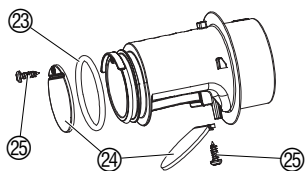
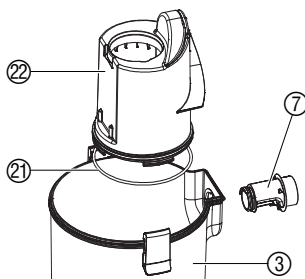

The sealing rings are obtainable via GARDENA Service.

→ Draw both hoses and the intake distributor out of the filter tray ③ (see 7. Maintenance).

Replace sealing ring ②① of the inner tank:

4. Draw inner tank ②② out of the filter tray ③.
5. Replace sealing ring ②① of the inner tank ②② and reinsert inner tank ②②.

Replace sealing rings ②③ and valve rubber ②④ of the intake distributor:

1. Draw intake distributor ⑦ out of the upper intake housing of the filter tray ③ (bayonet fitting).
2. Unscrew screws ②⑤ and replace valve rubbers ②④.
3. Replace sealing rings ②③ and valve rubber ②④ of the intake distributor ⑦ and reinsert intake distributor ⑦.

Replace valve rubber ②⑥ of the discharge aperture:

6. Draw inner tank ②② out of the filter tray ③ and unscrew screw ②⑦.
7. Replace valve rubber ②⑥ and reinsert inner tank ②②.

→ Reassemble pond silt remover in reverse order.

CAUTION!



Work on the electrical parts must only be carried out by GARDENA Service.

If other faults occur, please contact GARDENA Service.

9. Technical data

SR 2000 (Art. 7947)

Mains voltage / mains frequency 230 V AC / 50 Hz

Motor rating 1600 W

Connection cable 4 m H05-VV

Max. suction height 1.7 m

Filter tray volume 2 x 7 l

Suction hose length 5 m

Discharge hose length 2.5 m

Max. particle size for suction 20 mm

Liquid temperature 4 °C - 35 °C

Noise level ¹⁾ < 85 dB (A)

¹⁾ according to 98/37/EC

10. Service / Warranty

GARDENA guarantees this product for 3 years (starting from the date of purchase). This guarantee covers all serious defects of the unit that can be proved to be material or manufacturing faults. Under warranty we will either replace the unit or repair it free of charge if the following conditions apply:

- The unit must have been handled properly and in keeping with the requirements of the operating instructions.
- Neither the purchaser or a non-authorised third party have attempted to repair the unit.

The wearing parts, pieces of filter foam, sealing rings and valve rubbers, are excluded from the warranty.

This manufacturer's guarantee does not affect the user's existing warranty claims against the dealer/seller.

If a fault occurs with your Pond Silt Remover, please return the faulty unit together with a copy of the receipt and a description of the fault, with postage paid to one of the GARDENA Service Centres listed on the back of these operating instructions.

<p>D <i>Produkthftung</i></p>	<p>Wir weisen ausdrücklich darauf hin, dass wir nach dem Produkthaftungsgesetz nicht für durch unsere Geräte hervorgerufene Schäden einzustehen haben, sofern diese durch unsachgemäße Reparatur verursacht oder bei einem Teileaustausch nicht unsere Original GARDENA Teile oder von uns freigegebene Teile verwendet werden und die Reparatur nicht vom GARDENA Service oder dem autorisierten Fachmann durchgeführt wird. Entsprechendes gilt für Ergänzungssteile und Zubehör.</p>
<p>GB <i>Product Liability</i></p>	<p>We expressly point out that, in accordance with the product liability law, we are not liable for any damage caused by our products if it is due to improper repair or if parts exchanged are not original GARDENA parts or parts approved by us, and, if the repairs were not carried out by a GARDENA Service Centre or an authorised specialist. The same applies to spare parts and accessories.</p>
<p>F <i>Responsabilité</i></p>	<p>Nous vous signalons expressément que GARDENA n'est pas responsable des dommages causés par ses appareils, dans la mesure où ces dommages seraient causés suite à une réparation non conforme, dans la mesure où, lors d'un échange de pièces, les pièces d'origine GARDENA n'auraient pas été utilisées, ou si la réparation n'a pas été effectuée par le Service Après-Vente GARDENA ou l'un des Centres SAV agréés GARDENA. Ceci est également valable pour tout ajout de pièces et d'accessoires autres que ceux préconisés par GARDENA.</p>
<p>NL <i>Productaansprakelijkheid</i></p>	<p>Wij wijzen er nadrukkelijk op, dat wij op grond van de wet aansprakelijkheid voor producten niet aansprakelijk zijn voor schade ontstaan door onze apparaten, indien deze door onvakkundige reparatie veroorzaakt zijn, of er bij het uitwisselen van onderdelen geen gebruik gemaakt werd van onze originele GARDENA onderdelen of door ons vrijgegeven onderdelen en de reparatie niet door de GARDENA technische dienst of de bevoegde vakman uitgevoerd werd. Ditzelfde geldt voor extra-onderdelen en accessoires.</p>
<p>S <i>Produktansvar</i></p>	<p>Tillverkaren är inte ansvarig för skada som orsakats av produkten om skadan beror på att produkten har reparerats felaktigt eller om, vid reparation eller utbyte, andra än Original GARDENA reservdelar har använts. Samma sak gäller för kompletteringsdelar och tillbehör.</p>
<p>I <i>Responsabilità del prodotto</i></p>	<p>Si rende espressamente noto che, conformemente alla legislazione sulla responsabilità del prodotto, non si risponde di danni causati da nostri articoli se originati da riparazioni eseguite non correttamente o da sostituzioni di parti effettuate con materiale non originale GARDENA o comunque da noi non approvato e, in ogni caso, qualora l'intervento non venga eseguito da un centro assistenza GARDENA o da personale specializzato autorizzato. Lo stesso vale per le parti complementari e gli accessori.</p>
<p>E <i>Responsabilidad de productos</i></p>	<p>Advertimos que conforme a la ley de responsabilidad de productos no nos responsabilizamos de daños causados por nuestros aparatos, siempre y cuando dichos daños hayan sido originados por arreglos o reparaciones indebidas, por recambios con piezas que no sean piezas originales GARDENA o bien piezas autorizadas por nosotros, así como en aquellos casos en que la reparación no haya sido efectuada por un Servicio Técnico GARDENA o por un técnico autorizado. Lo mismo es aplicable para las piezas complementarias y accesorios.</p>
<p>P <i>Responsabilidade sobre o produto</i></p>	<p>Queremos salientar que segundo a lei da responsabilidade do fabricante, nós não nos responsabilizaremos por danos causados pelo nosso equipamento, quando estes ocorram em decorrência de reparações inadequadas ou da substituição de peças por peças não originais da GARDENA, ou peças não autorizadas. A responsabilidade tornar-se-á nula também depois de reparações realizadas por oficinas não autorizadas pela GARDENA. Esta restrição valerá também para peças adicionais e acessórios.</p>
<p>DK <i>Produktansvar</i></p>	<p>Vi gør udtrykkeligt opmærksom på at i henhold til produktansvarsloven er vi ikke ansvarlige for skader forårsaget af vores udstyr, hvis det skyldes uautoriserede reparationer eller hvis dele er skiftet ud og der ikke er anvendt originale GARDENA dele eller dele godkendt af os, eller hvis reparationerne ikke er udført af GARDENA-service eller en autoriseret fagmand. Det samme gælder for ekstra udstyr og tilbehør.</p>

<p>D EU-Konformitätserklärung Maschinenverordnung (9. GSGVO) / EMVG / Niedersp. RL Der Unterzeichnete GARDENA Manufacturing GmbH, Hans-Lorenser-Str. 40, D-89079 Ulm, bestätigt, dass die nachfolgend bezeichneten Geräte in der von uns in Verkehr gebrachten Ausführung die Anforderungen der harmonisierten EU-Richtlinien, EU-Sicherheitsstandards und produktspezifischen Standards erfüllen. Bei einer nicht mit uns abgestimmten Änderung der Geräte verliert diese Erklärung ihre Gültigkeit.</p>	<table border="0"> <tr> <td>Bezeichnung des Gerätes:</td> <td>Teichschlammsauger</td> </tr> <tr> <td>Description of the product:</td> <td>Pond Silt Remover</td> </tr> <tr> <td>Désignation du matériel :</td> <td>Aspirateur de bassin</td> </tr> <tr> <td>Onmschrijving van het apparaat:</td> <td>Vijvervuilzuiger</td> </tr> <tr> <td>Produktbeskrivning:</td> <td>Slamsugår för Damms</td> </tr> <tr> <td>Descrizione del prodotto:</td> <td>Pulitore per laghetti</td> </tr> <tr> <td>Descripción de la mercancía:</td> <td>Aspirador de lodos para estanque</td> </tr> </table>	Bezeichnung des Gerätes:	Teichschlammsauger	Description of the product:	Pond Silt Remover	Désignation du matériel :	Aspirateur de bassin	Onmschrijving van het apparaat:	Vijvervuilzuiger	Produktbeskrivning:	Slamsugår för Damms	Descrizione del prodotto:	Pulitore per laghetti	Descripción de la mercancía:	Aspirador de lodos para estanque				
Bezeichnung des Gerätes:	Teichschlammsauger																		
Description of the product:	Pond Silt Remover																		
Désignation du matériel :	Aspirateur de bassin																		
Onmschrijving van het apparaat:	Vijvervuilzuiger																		
Produktbeskrivning:	Slamsugår för Damms																		
Descrizione del prodotto:	Pulitore per laghetti																		
Descripción de la mercancía:	Aspirador de lodos para estanque																		
<p>GB EU Certificate of Conformity The undersigned GARDENA Manufacturing GmbH, Hans-Lorenser-Str. 40, D-89079 Ulm, hereby certifies that, when leaving our factory, the units indicated below are in accordance with the harmonised EU guidelines, EU standards of safety and product specific standards. This certificate becomes void if the products are modified without our approval.</p>	<table border="0"> <tr> <td>Descrição do aparelho:</td> <td>Aspirador de lodo de lago</td> </tr> <tr> <td>Beskrivelse af enhederne:</td> <td>Bassinstøvsuger</td> </tr> </table>	Descrição do aparelho:	Aspirador de lodo de lago	Beskrivelse af enhederne:	Bassinstøvsuger														
Descrição do aparelho:	Aspirador de lodo de lago																		
Beskrivelse af enhederne:	Bassinstøvsuger																		
<p>F Certificat de conformité aux directives européennes Le constructeur, soussigné : GARDENA Manufacturing GmbH, Hans-Lorenser-Str. 40, D-89079 Ulm, déclare qu'à la sortie de ses usines le matériel neuf désigné ci-dessous était conforme aux prescriptions des directives européennes énoncées ci-après et conforme aux règles de sécurité et autres règles qui lui sont applicables dans le cadre de l'Union européenne. Toute modification portée sur ce produit sans l'accord express de GARDENA supprime la validité de ce certificat.</p>	<table border="0"> <tr> <td>Typ:</td> <td>Art.-Nr.:</td> </tr> <tr> <td>Type:</td> <td>Art. No.:</td> </tr> <tr> <td>Type :</td> <td>Référence :</td> </tr> <tr> <td>Type :</td> <td>Art. nr.:</td> </tr> <tr> <td>Type: SR 2000</td> <td>Art.nr. : 7947</td> </tr> <tr> <td>Modello:</td> <td>Art.:</td> </tr> <tr> <td>Tipo:</td> <td>Art. Nº:</td> </tr> <tr> <td>Tipo:</td> <td>Art. Nº:</td> </tr> <tr> <td>Type:</td> <td>Varenr. :</td> </tr> </table>	Typ:	Art.-Nr.:	Type:	Art. No.:	Type :	Référence :	Type :	Art. nr.:	Type: SR 2000	Art.nr. : 7947	Modello:	Art.:	Tipo:	Art. Nº:	Tipo:	Art. Nº:	Type:	Varenr. :
Typ:	Art.-Nr.:																		
Type:	Art. No.:																		
Type :	Référence :																		
Type :	Art. nr.:																		
Type: SR 2000	Art.nr. : 7947																		
Modello:	Art.:																		
Tipo:	Art. Nº:																		
Tipo:	Art. Nº:																		
Type:	Varenr. :																		
<p>NL EU-overeenstemmingsverklaring Ondergetekende GARDENA Manufacturing GmbH, Hans-Lorenser-Str. 40, D-89079 Ulm, bevestigt, dat de volgende genoemde apparaten in de door ons in de handel gebrachte uitvoering voldoen aan de eis van, en in overeenstemming zijn met de EU-richtlijnen, de EU-veiligheidsstandaard en de voor het product specifieke standaard. Bij een niet met ons afgestemde verandering aan de apparaten verliest deze verklaring haar geldigheid.</p>	<table border="0"> <tr> <td>EU-Richtlijnen:</td> <td></td> </tr> <tr> <td>EU directives:</td> <td>89/336/EC</td> </tr> <tr> <td>Directives européennes :</td> <td></td> </tr> <tr> <td>EU-richtlijnen :</td> <td>73/23/EC</td> </tr> <tr> <td>EU direktiv :</td> <td></td> </tr> <tr> <td>Directive UE :</td> <td>93/68/EC</td> </tr> <tr> <td>Normativa UE :</td> <td>98/37/EC</td> </tr> <tr> <td>Directrices da UE :</td> <td></td> </tr> <tr> <td>EU Retningslinier :</td> <td></td> </tr> </table>	EU-Richtlijnen:		EU directives:	89/336/EC	Directives européennes :		EU-richtlijnen :	73/23/EC	EU direktiv :		Directive UE :	93/68/EC	Normativa UE :	98/37/EC	Directrices da UE :		EU Retningslinier :	
EU-Richtlijnen:																			
EU directives:	89/336/EC																		
Directives européennes :																			
EU-richtlijnen :	73/23/EC																		
EU direktiv :																			
Directive UE :	93/68/EC																		
Normativa UE :	98/37/EC																		
Directrices da UE :																			
EU Retningslinier :																			
<p>S EU Tillverkarintyg Undertecknad firma GARDENA Manufacturing GmbH, Hans-Lorenser-Str. 40, D-89079 Ulm, intygar härmed att nedan nämnda produkter överensstämmer med EU:s direktiv, EU:s säkerhetsstandard och produktspecifikation. Detta intyg upphör att gälla om produkten ändras utan vårt tillstånd.</p>	<table border="0"> <tr> <td>Anbringningsår der CE-Kennzeichnung:</td> <td></td> </tr> <tr> <td>Year of CE marking:</td> <td></td> </tr> <tr> <td>Date d'apposition du marquage CE :</td> <td></td> </tr> <tr> <td>Installatiejaar van de CE-aanduiding:</td> <td>2005</td> </tr> <tr> <td>CE-Mærkningsår :</td> <td></td> </tr> <tr> <td>Anno di rilascio della certificazione CE :</td> <td></td> </tr> <tr> <td>Colocación del distintivo CE :</td> <td></td> </tr> <tr> <td>Ano de marcação pela CE :</td> <td></td> </tr> <tr> <td>CE-Mærkningsår :</td> <td></td> </tr> </table>	Anbringningsår der CE-Kennzeichnung:		Year of CE marking:		Date d'apposition du marquage CE :		Installatiejaar van de CE-aanduiding:	2005	CE-Mærkningsår :		Anno di rilascio della certificazione CE :		Colocación del distintivo CE :		Ano de marcação pela CE :		CE-Mærkningsår :	
Anbringningsår der CE-Kennzeichnung:																			
Year of CE marking:																			
Date d'apposition du marquage CE :																			
Installatiejaar van de CE-aanduiding:	2005																		
CE-Mærkningsår :																			
Anno di rilascio della certificazione CE :																			
Colocación del distintivo CE :																			
Ano de marcação pela CE :																			
CE-Mærkningsår :																			
<p>I Dichiarazione di conformità alle norme UE La sottoscritta GARDENA Manufacturing GmbH, Hans-Lorenser-Str. 40, D-89079 Ulm, certifica che il prodotto qui di seguito indicato, nei modelli da noi commercializzati, è conforme alle direttive armonizzate UE nonché agli standard di sicurezza e agli standard specifici di prodotto. Qualunque modifica apportata al prodotto senza nostra specifica autorizzazione invalida la presente dichiarazione.</p>	<table border="0"> <tr> <td>Ulm, den 01.06.2005</td> <td></td> </tr> <tr> <td>Ulm, 01.06.2005</td> <td></td> </tr> <tr> <td>Fait à Ulm, le 01.06.2005</td> <td></td> </tr> <tr> <td>Ulm, 01-06-2005</td> <td></td> </tr> <tr> <td>Ulm, 2005.06.01.</td> <td></td> </tr> <tr> <td>Ulm, 01.06.2005</td> <td></td> </tr> <tr> <td>Ulm, 01.06.2005</td> <td></td> </tr> <tr> <td>Ulm, 01.06.2005</td> <td></td> </tr> <tr> <td>Ulm, 01.06.2005</td> <td></td> </tr> </table>	Ulm, den 01.06.2005		Ulm, 01.06.2005		Fait à Ulm, le 01.06.2005		Ulm, 01-06-2005		Ulm, 2005.06.01.		Ulm, 01.06.2005		Ulm, 01.06.2005		Ulm, 01.06.2005		Ulm, 01.06.2005	
Ulm, den 01.06.2005																			
Ulm, 01.06.2005																			
Fait à Ulm, le 01.06.2005																			
Ulm, 01-06-2005																			
Ulm, 2005.06.01.																			
Ulm, 01.06.2005																			
Ulm, 01.06.2005																			
Ulm, 01.06.2005																			
Ulm, 01.06.2005																			
<p>E Declaración de conformidad de la UE El que suscribe GARDENA Manufacturing GmbH, Hans-Lorenser-Str. 40, D-89079 Ulm, declara que la presente mercancía, objeto de la presente declaración, cumple con todas las normas de la UE, en lo que a normas técnicas, de homologación y de seguridad se refiere. En caso de realizar cualquier modificación en la presente mercancía sin nuestra previa autorización, esta declaración pierde su validez.</p>	<table border="0"> <tr> <td>Ulm, 01.06.2005</td> <td></td> </tr> <tr> <td>Ulm, 01.06.2005</td> <td></td> </tr> <tr> <td>Fait à Ulm, le 01.06.2005</td> <td></td> </tr> <tr> <td>Ulm, 01-06-2005</td> <td></td> </tr> <tr> <td>Ulm, 2005.06.01.</td> <td></td> </tr> <tr> <td>Ulm, 01.06.2005</td> <td></td> </tr> <tr> <td>Ulm, 01.06.2005</td> <td></td> </tr> <tr> <td>Ulm, 01.06.2005</td> <td></td> </tr> <tr> <td>Ulm, 01.06.2005</td> <td></td> </tr> </table>	Ulm, 01.06.2005		Ulm, 01.06.2005		Fait à Ulm, le 01.06.2005		Ulm, 01-06-2005		Ulm, 2005.06.01.		Ulm, 01.06.2005		Ulm, 01.06.2005		Ulm, 01.06.2005		Ulm, 01.06.2005	
Ulm, 01.06.2005																			
Ulm, 01.06.2005																			
Fait à Ulm, le 01.06.2005																			
Ulm, 01-06-2005																			
Ulm, 2005.06.01.																			
Ulm, 01.06.2005																			
Ulm, 01.06.2005																			
Ulm, 01.06.2005																			
Ulm, 01.06.2005																			
<p>P Certificado de conformidad da UE Os abaixo mencionados GARDENA Manufacturing GmbH, Hans-Lorenser-Str. 40, D-89079 Ulm, por este meio certificam que ao sair da fábrica o aparelho abaixo mencionado está de acordo com as directrizes harmonizadas da UE, padrões de segurança e de produtos específicos. Este certificado ficará nulo se a unidade for modificada sem a nossa aprovação.</p>	<table border="0"> <tr> <td>Ulm, 01.06.2005</td> <td></td> </tr> <tr> <td>Ulm, 01.06.2005</td> <td></td> </tr> <tr> <td>Fait à Ulm, le 01.06.2005</td> <td></td> </tr> <tr> <td>Ulm, 01-06-2005</td> <td></td> </tr> <tr> <td>Ulm, 2005.06.01.</td> <td></td> </tr> <tr> <td>Ulm, 01.06.2005</td> <td></td> </tr> <tr> <td>Ulm, 01.06.2005</td> <td></td> </tr> <tr> <td>Ulm, 01.06.2005</td> <td></td> </tr> <tr> <td>Ulm, 01.06.2005</td> <td></td> </tr> </table>	Ulm, 01.06.2005		Ulm, 01.06.2005		Fait à Ulm, le 01.06.2005		Ulm, 01-06-2005		Ulm, 2005.06.01.		Ulm, 01.06.2005		Ulm, 01.06.2005		Ulm, 01.06.2005		Ulm, 01.06.2005	
Ulm, 01.06.2005																			
Ulm, 01.06.2005																			
Fait à Ulm, le 01.06.2005																			
Ulm, 01-06-2005																			
Ulm, 2005.06.01.																			
Ulm, 01.06.2005																			
Ulm, 01.06.2005																			
Ulm, 01.06.2005																			
Ulm, 01.06.2005																			
<p>DK EU Overensstemmelse certificat Undertegnede GARDENA Manufacturing GmbH, Hans-Lorenser-Str. 40, D-89079 Ulm bekræfter hermed, at enheder listet herunder, ved afsendelse fra fabrikken, er i overensstemmelse med harmoniserede EU retningslinier, EU sikkerhedsstandarder og produktspecifikationsstandarder. Dette certifikat træder ud af kraft hvis enhederne er ændret uden vor godkendelse.</p>	<table border="0"> <tr> <td>Ulm, 01.06.2005</td> <td></td> </tr> <tr> <td>Ulm, 01.06.2005</td> <td></td> </tr> <tr> <td>Fait à Ulm, le 01.06.2005</td> <td></td> </tr> <tr> <td>Ulm, 01-06-2005</td> <td></td> </tr> <tr> <td>Ulm, 2005.06.01.</td> <td></td> </tr> <tr> <td>Ulm, 01.06.2005</td> <td></td> </tr> <tr> <td>Ulm, 01.06.2005</td> <td></td> </tr> <tr> <td>Ulm, 01.06.2005</td> <td></td> </tr> <tr> <td>Ulm, 01.06.2005</td> <td></td> </tr> </table>	Ulm, 01.06.2005		Ulm, 01.06.2005		Fait à Ulm, le 01.06.2005		Ulm, 01-06-2005		Ulm, 2005.06.01.		Ulm, 01.06.2005		Ulm, 01.06.2005		Ulm, 01.06.2005		Ulm, 01.06.2005	
Ulm, 01.06.2005																			
Ulm, 01.06.2005																			
Fait à Ulm, le 01.06.2005																			
Ulm, 01-06-2005																			
Ulm, 2005.06.01.																			
Ulm, 01.06.2005																			
Ulm, 01.06.2005																			
Ulm, 01.06.2005																			
Ulm, 01.06.2005																			
<p>DK EU Overensstemmelse certificat Undertegnede GARDENA Manufacturing GmbH, Hans-Lorenser-Str. 40, D-89079 Ulm bekræfter hermed, at enheder listet herunder, ved afsendelse fra fabrikken, er i overensstemmelse med harmoniserede EU retningslinier, EU sikkerhedsstandarder og produktspecifikationsstandarder. Dette certifikat træder ud af kraft hvis enhederne er ændret uden vor godkendelse.</p>	<table border="0"> <tr> <td>Ulm, 01.06.2005</td> <td></td> </tr> <tr> <td>Ulm, 01.06.2005</td> <td></td> </tr> <tr> <td>Fait à Ulm, le 01.06.2005</td> <td></td> </tr> <tr> <td>Ulm, 01-06-2005</td> <td></td> </tr> <tr> <td>Ulm, 2005.06.01.</td> <td></td> </tr> <tr> <td>Ulm, 01.06.2005</td> <td></td> </tr> <tr> <td>Ulm, 01.06.2005</td> <td></td> </tr> <tr> <td>Ulm, 01.06.2005</td> <td></td> </tr> <tr> <td>Ulm, 01.06.2005</td> <td></td> </tr> </table>	Ulm, 01.06.2005		Ulm, 01.06.2005		Fait à Ulm, le 01.06.2005		Ulm, 01-06-2005		Ulm, 2005.06.01.		Ulm, 01.06.2005		Ulm, 01.06.2005		Ulm, 01.06.2005		Ulm, 01.06.2005	
Ulm, 01.06.2005																			
Ulm, 01.06.2005																			
Fait à Ulm, le 01.06.2005																			
Ulm, 01-06-2005																			
Ulm, 2005.06.01.																			
Ulm, 01.06.2005																			
Ulm, 01.06.2005																			
Ulm, 01.06.2005																			
Ulm, 01.06.2005																			

Peter Lameli

Peter Lameli
Technische Leitung
Technical Dept. Manager
Direction technique
Hoofd technische dienst
Technical Director
Direzione Tecnica
Dirección Técnica
Director Técnico
Teknisk direktør

Deutschland / Germany

GARDENA
Manufacturing GmbH
Service Center
Hans-Lorenser-Straße 40
D-89079 Ulm
Produktfragen:
(+49) 731 490-123
Reparaturen:
(+49) 731 490-290
service@gardena.com

Argentina

Argensem® S.A.
Calle Colonia Japonesa s/n
(1625) Loma Verde
Escobar, Buenos Aires
Phone: (+54) 34 88 49 40 40
info@argensem.com.ar

Australia

Nylex Consumer Products
50-70 Stanley Drive
Somerton, Victoria, 3062
Phone: (+61) 1800 658 276
spare.parts@nylex.com.au

Austria / Österreich

GARDENA
Österreich Ges.m.b.H.
Stettnerweg 11-15
2100 Korneuburg
Tel.: (+43) 22 62 7 45 45 36
kundendienst@gardena.at

Belgium

GARDENA Belgium NV/SA
Sterrebeekstraat 163
1930 Zaventem
Phone: (+32) 2 720 92 12
Mail: info@gardena.be

Brazil

Palash Comércio e
Importação Ltda.
Rua Américo Brasiliense,
2414 - Chácara Sto Antonio
São Paulo - SP - Brasil -
CEP 04715-005
Phone: (+55) 11 5181-0909
eduardo@palash.com.br

Bulgaria

DENEX LTD.
2 Luis Ahalier Str. - 7th floor
Sofia 1404
Phone: (+359) 2 958 18 21
office@denex-bg.com

Canada

GARDENA Canada Ltd.
100 Summerlea Road
Brampton, Ontario L6T 4X3
Phone: (+1) 905 792 93 30
info@gardenacanada.com

Chile

Antonio Martinic y Cia Ltda.
Cassillas 272
Centro de Cassillas
Santiago de Chile
Phone: (+56) 2 20 10 708
garfar_cl@yahoo.com

Costa Rica

Compania Exim
Euroberoamericana S.A.
Los Colegios, Moravia,
200 metros al Sur del Colegio
Saint Francis - San José
Phone: (+506) 297 68 83
exim_euro@racsa.co.cr

Croatia

KLIS d.o.o.
Stancecva 79
10419 Vukovina
Phone: (+385) 1 622 777 0
gardena@klis-trgovina.hr

Cyprus

FARMOKIPIKI LTD
P.O. Box 7098
74, Digeni Akritra Ave.
1641 Nicosia
Phone: (+357) 22 75 47 62
condam@spidernet.com.cy

Czech Republic

GARDENA spol. s r.o.
Řípská 20a, č.p. 1153
627 00 Brno
Phone: (+420) 800 100 425
gardena@gardenabrno.cz

Denmark

GARDENA Norden AB
Salgsafdeling Danmark
Box 9003
S-200 39 Malmö
info@gardena.dk

Finland

Habitec Oy
Martinkyläntie 52
01720 Vantaa

France

GARDENA
PARIS NORD 2
69, rue de la Belle Etoile
BP 57080
ROISSY EN FRANCE
95948 ROISSY CDG CEDEX
Tél. (+33) 0826 101 455
service.consommateurs@
gardena.fr

Great Britain

GARDENA UK Ltd.
27-28 Brenkley Way
Bleazard Business Park
Seaton Burn
Newcastle upon Tyne
NE13 6DS
info@gardena.co.uk

Greece

Agrokrip
G. Psomadopoulos & Co.
33 A, Ifestou Str. –
Industrial Area
194 00 Koropi, Athens
Phone: (+30) 210 66 20 225
service@agrokrip.gr
www.agrokrip.gr

Hungary

GARDENA
Magyarország Kft.
Késmárk utca 22
1158 Budapest
Phone: (+36) 80 20 40 33
gardena@gardena.hu

Iceland

Ó. Johnson & Kaaber
Tunguhalsi 1
110 Reykjavik
oaj@ojk.is

Ireland

Michael McLoughlin & Sons
Hardware Limited
Long Mile Road
Dublin 12

Italy

GARDENA Italia S.p.A.
Via Donizetti 22
20020 Lainate (Mi)
Phone: (+39) 02.93.94.79.1
info@gardenaitalia.it

Japan

KAKUICHI Co. Ltd.
Sumitomo Realty &
Development Kojimachi
BLDG., 8F
5-1 Nibannoyo, Chiyoda-ku
Tokyo 102-0084
Phone: (+81) 33 264 4721
m_ishihara@kaku-ichi.co.jp

Luxembourg

Magasins Jules Neuberg
Grand Rue 30
Boîte postale 12
L-2010 Luxembourg
Phone: (+352) 40 14 01
info@neuberg.lu

Netherlands

GARDENA Nederland B.V.
Postbus 50176
1305 AD ALMERE
Phone: (+31) 36 521 00 00
info@gardena.nl

Neth. Antilles

Jonka Enterprises N.V.
Sta. Rosa Weg 196
P.O. Box 8200
Curaçao
Phone: (+599) 9 767 66 55
pgm@jonka.com

New Zealand

NYLEX New Zealand Limited
Building 2, 118 Savill Drive
Mangere, Auckland
Phone: (+64) 9 270 1806
lena.chapman@nylex.com.au

Norway

GARDENA Norden AB
Salgskontor Norge
Karihaugveien 89
1086 Oslo
info@gardena.no

Poland

GARDENA Polska Sp. z o.o.
Szymanów 9 d
05-532 Baniocza
Phone: (+48) 22 727 56 90
gardena@gardena.pl

Portugal

GARDENA Portugal Lda.
Recta da Granja do Marquês
Edif. GARDENA Algueirão
2725-596 Mem Martins
Phone: (+351) 21 922 85 30
info@gardena.pt

Romania

MADEX INTERNATIONAL SRL
Soseaua Odaii 117-123,
Sector 1,
București, RO 013603
Phone: (+40) 21 352 76 03
madex@ines.ro

Russia / Россия

АО АМИДА ТТЦ
ул. Мосфильмовская 66
117330 Москва
Phone: (+7) 095 956 99 00
amida@col.ru

Singapore

Hy - Ray PRIVATE LIMITED
40 Jalan Pemimpin
#02-08 Tat Ann Building
Singapore 577185
Phone: (+65) 6253 2277
hyray@singnet.com.sg

Slovak Republic

GARDENA Slovensko, s.r.o.
Panónska cesta 17
851 04 Bratislava
Phone: (+421) 263 453 722
info@gardena.sk

Slovenia

Silk d.o.o.
Brodšče 15
1236 Trzin
Phone: (+386) 1 580 93 00
gardena@silks.si

South Africa

GARDENA
South Africa (Pty.) Ltd.
P.O. Box 11534
Vorna Valley 1686
Phone: (+27) 11 315 02 23
sales@gardena.co.za

Spain

GARDENA IBÉRICA S.L.U.
C/ Basauri, nº 6
La Florida
28023 Madrid
Phone: (+34) 91 708 05 00
atencioncliente@gardena.es

Sweden

GARDENA Norden AB
Försäljningskontor Sverige
Box 9003
200 39 Malmö
info@gardena.se

Switzerland / Schweiz

GARDENA (Schweiz) AG
Bitzberg 1
8184 Bachenbülach
Phone: (+41) 848 800 464
info@gardena.ch

Turkey

GARDENA / Dost Diş Ticaret
Müessesilik A.Ş. Sanayi
Çad. Adil Sokak No.1
Kartal - İstanbul
Phone: (+90) 216 38 93 939
info@gardena-dost.com.tr

Ukraine / Україна

ALTSEST JSC
4 Petropavlivska Street
Petropavlivska
Borschahivka Town
Kyivo Svyatoslyn Region
08130, Ukraine
Phone: (+380) 44 459 57 03
upyr@altsest.kiev.ua

USA

Melnor Inc.
3085 Shawnee Drive
Winchester, VA 22604
Phone: (+1) 540 722-9080
service_us@melnor.com

7947-20.960.02/0606
© GARDENA
Manufacturing GmbH
D-89070 Ulm
http://www.gardena.com