

5000/3 SGP Art. 1471

D Gebrauchsanweisung

Duo-Pumpe

GB Operating Instructions

Dual Pump

F Mode d'emploi

Pompe universelle

NL Gebruiksaanwijzing

Duopomp

S Bruksanvisning

Universalpump

I Istruzioni per l'uso

Pompa Duo

E Manual de instrucciones

Bomba dúo

P Instruções de utilização

Bomba dupla

DK Brugsanvisning

Universalpumpe

GARDENA Dual Pump 5000/3 SGP

Welcome to the Garden of GARDENA ...



Please read these operating instructions carefully and observe the notes given. Use these operating instructions to familiarise yourself with the Dual Pump, its correct use and the notes on safety.



For safety reasons, children under the age of 16 as well as persons not familiar with these operating instructions should not use this Dual Pump.

→ Please keep these instructions in a safe place.

Contents

1. Where to Use Your GARDENA Dual Pump	11
2. For Your Safety	11
3. Initial Operation	13
4. Operation	14
5. Maintenance	14
6. Trouble-Shooting	14
7. Storage	16
8. Accessories	16
9. Technical Data	17
10. Service	17

1. Where to Use Your GARDENA Dual Pump

Intended use

The GARDENA Dual Pump has been designed for private use around house and garden.

Liquids to be pumped

The GARDENA Dual Pump can be used for pumping rainwater, tap water or chlorinated swimming pool water.

The pump is fully submersible (waterproof sealed) and can be immersed in the liquid down to a depth of 9 m.

Please note



The GARDENA Dual Pump is not designed for continuous operation (e.g. industrial application, continuous circulating operation). Corrosive, easily combustible, aggressive or explosive substances (e.g. gasoline, petroleum or nitro thinner), salt water as well as food must not be pumped. The temperature of the liquid should not exceed 35 °C.

2. For Your Safety

Residual-current device

According to DIN VDE (German Electrical Engineers' Association) 0100, submersible pumps may only be used in swimming pools, garden ponds, and fountains if the pump is operated via a residual-current device with a residual-current rating of ≤ 30 mA. The pump must not be operated when there are persons in the swimming pool or garden pond.

For safety reasons we recommend that you always operate the Dual Pump via a residual-current device (DIN VDE 0100-702 and 0100-738).

→ Please contact your electrician.

In Austria

In Austria, according to ÖVE B/EN 60 555 part 1 to 3, pumps which are used in swimming pools and garden ponds, and equipped with firm power cable should be fed via an ÖVE approved isolating transformer – rated voltage must not exceed 230 V.

In Switzerland

In Switzerland mobile appliances which are used outdoors, must be connected via a residual-current device.

Mains power

According to DIN VDE (German Electrical Engineers' Association) 0620, mains power cables must not have a smaller cross-section than the rubber-sheathed cables of the designation H07 RNF. The cable length must be at least 10 m.

Data indicated on the type plate must match technical data of the mains supply.

→ Take care that the electrical connections are made within dry area, protected from flooding.

Protect plug and power cable from heat, oil and sharp edges.

→ Don't use the power cable for plugging off.

The power cable must not be used for mounting or relocating the pump. For submerging or lifting/securing the pump, fix a rope (available from GARDENA Service) to the pump's carrying handle.

Extension cables must meet the requirements of DIN VDE 0620.

Visual check

→ Before operating the pump, first make a visual check, if there is any damage of the pump (esp. regarding power cable and plug).

→ Observe the minimum water level and the max. delivery height (see 9. Technical Data).

A damaged pump must not be used.

→ In case of damage, please have the pump checked by our GARDENA Service Centre.

Note on use

→ Clear the outlet line before use.

When setting up the pump for use out of water

In order to avoid dry-running of the pump, take care that the end of the suction hose is always submerged into the liquid.

→ Before each operation, fill the pump to overflowing with approx. 2 l of the liquid to be pumped!

Liquid fails to flow

Sand and other abrasive substances in the liquid cause increased wear and reduce the pump's output.

→ Use a Pump Preliminary Filter if the water contains sand (Art. No. 1730/1731).

The pump should not run against the closed delivery side for more than 5 minutes.

→ If liquid fails to flow, switch off the pump immediately.

Minimum flow rate

The minimum flow rate is 80 l/h (= 1.3 l/min).

Watering accessories with lower rate must not be operated.

Hot water – risk of scalding



If the pump is operated for prolonged periods of time (> 5 min) with the delivery side closed, the water in the pump may heat up so that there is a risk of scalding yourself with hot water.

→ The pump should not run against the closed delivery side for more than 5 minutes.

→ If liquid fails to flow, switch off the pump immediately.

3. Initial Operation

Connecting a filter or hose to the inlet side:

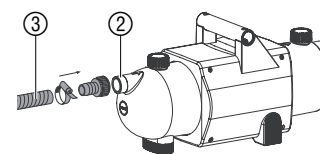
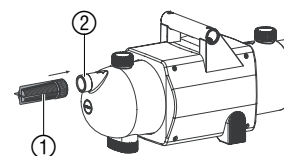

1. When setting up the pump **for use underwater**, screw the **filter** ① onto the connection ② at the inlet side of the pump.

– or –

When setting up the pump **for use out of water**, connect a **vacuum-resistant suction hose** ③ **with filter** to the connection ② at the inlet side of the pump and screw on so that the connection is air-tight.

2. When setting up the pump **for use out of water** with suction heights over 4 m, the suction hose should also be secured (fastened to a wooden peg for example).

The pump is relieved of the weight of the suction hose.

Don't use any hose connection system fittings on the suction side! A vacuum-resistant suction hose must be used

- e.g. GARDENA Suction Unit, **art. no. 1411**.

In order to reduce the suction time, it is advisable to use a suction hose with backflow preventer avoiding automatic draining of the suction hose when the pump is stopped.

Connection hose to delivery side:

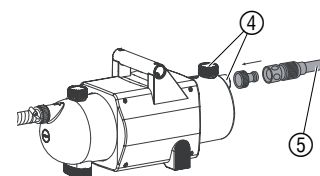

Both pump connectors ④ are equipped with a 33.3 mm (G 1") thread to which 13 mm (1/2"), 19 mm (3/4") and 16 mm (5/8") hoses can be connected by using GARDENA hose connection system fittings.

Best results regarding the delivery capacity of the pump are achieved when connecting 19 mm (3/4") hoses in conjunction with e.g.

- GARDENA Pump Connection Set, **art. no. 1752**, or when using 25 mm (1") hoses with fittings available from your sanitary dealer.

→ Connect the pressure hose ⑤ to the connector ④ on the delivery side.

Only when setting up the pump for use out of water:

→ Before each operation, fill the pump to overflowing with approx. 2 l of the liquid to be pumped!

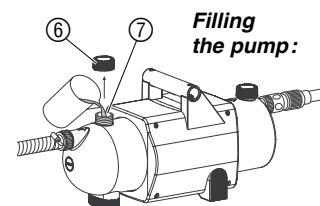

- Unscrew the screw fitting ⑥ of the filler cap ⑦ by hand.
- Fill the pump via the filler cap ⑦ to overflowing with approx. 2 l of the liquid to be pumped.
- Tighten the screw fitting ⑥ of the filler cap ⑦ by hand (do not use pliers).

4. Operation

Starting the pump:

When setting up the pump for use in water:

→ Plug the mains plug of the pump into a 230 V / 50 Hz alternating current socket. *The pump starts.*

When setting up the pump for use out of water

1. Fill the pump to overflowing with approx. 2 l of the liquid to be pumped (see "3. Initial Operation", "Filling the pump").
 2. Open all possible shut-off devices in the pressure line (watering accessories, Water Stop, etc.).
 3. Drain remaining water in pressure hose so that air can escape during the suction process.
 4. Plug the mains plug of the pump into a 230 V / 50 Hz alternating current socket. *The pump starts.*
 5. Hold the hose ⑤ at the delivery side approx. 1 m vertically above the pump until the pump begins to pump.
- If the pump has still not started pumping after 7 minutes, unplug the mains plug (see 6. Trouble Shooting).

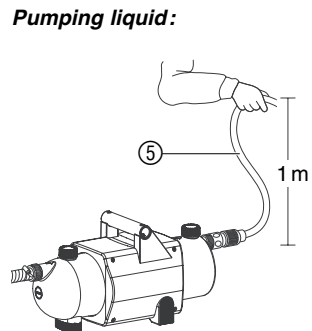

When using the pump for pressure intensification, the max. permissible internal pressure of 6 bar (on the delivery side) must not be exceeded. The to be increased delivery pressure and the pump pressure sum up.

- Example: pressure at the water tap 1.5 bar, max. pressure of the GARDENA Dual Pump 5000/3 SGP = 3.3 bar, total pressure = 4.8 bar.

5. Maintenance

The GARDENA Dual Pump is virtually maintenance-free.

6. Trouble-Shooting

Freeing the impeller:

If the impeller blocks or clogs you can remove the dirt to free the impeller.

1. Unscrew the screw plug ⑧ using a screwdriver.
2. You can now turn the impeller shaft ⑨ in the casing using a screwdriver. *This will free the blocked or clogged impeller.*
3. Replace the screw plug ⑧ using a screwdriver.

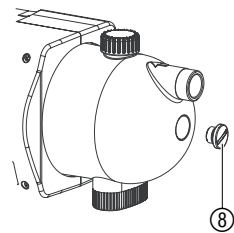
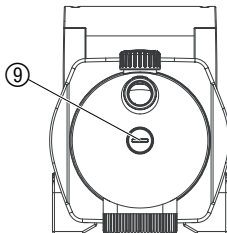

Problem	Probable cause	Remedy
Pump runs, but the suction action doesn't take place.	Air cannot escape, since delivery side is closed or remaining water is in the pressure hose.	→ Open all possible shut-off devices (e.g. spray nozzle) in the pressure line, or drain the pressure hose or disconnect it during the suction action.
Pump runs when out of water but does not start pumping when in water	You didn't fill the pump with any liquid before operation. The liquid escapes over the hose which is connected to the delivery side during the suction action.	→ Fill in liquid (see point "3. Initial Operation"). 1. Fill up the pump again (see point 3. Initial Operation). 2. When starting operation hold the pressure hose approx. 1 m vertically above the pump, until the suction action has taken place.
	Leaky or damaged suction hose.	→ Seal the connections or check suction hose for damages. Absolutely vacuum-resistant connection is achieved by using GARDENA Suction Hoses (see point "8. Accessories").
	Leaky screw fitting at the filler cap ⑦.	→ Tighten the screw fitting (do not use pliers).
	Air cannot escape, since delivery side is closed or remaining water is in the pressure hose.	→ Open all possible shut-off devices (e.g. spray nozzle) in the pressure line, or drain the pressure hose or disconnect it during the suction action.
	The waiting time wasn't observed.	→ Switch on the pump and wait max. 7 min.
	Suction filter or backflow preventer in the suction hose clogged.	→ Clean the filter or the backflow preventer.
	Too high suction height.	→ Reduce suction height.
	In case of any other difficulties concerning the suction action, use GARDENA Suction Hoses with Backflow Preventer (see point "8. Accessories") and fill in the liquid to be pumped over the filler cap ⑦ before operation.	
The specified maximum self-priming height is not	Pump is not filled and suction hose is not held upwards.	1. Fill the pump using the filler neck until it overflows. 2. Hold the suction hose upwards during the self-priming phase so that the liquid you are going to pump cannot flow out of the pump via the suction hose.

Problem	Probable cause	Remedy
Pump motor runs, but delivery capacity or pressure suddenly decreases.	Suction filter at the suction hose is sucked free.	→ Reduce flow rate on the delivery side with a regulator valve, e.g. GARDENA art. no. (2)977.
	Suction filter or backflow preventer clogged.	→ Clean filter or back-flow preventer.
	Impeller blocked.	→ Free the impeller.
Pump motor doesn't start or suddenly stops.	No power.	→ Check fuses and electric connections.
	Thermal overload switch has cut out the pump due to overheating/overloading.	→ Free the impeller and open the pressure side.
	Impeller clogged.	→ Send the pump to one of our GARDENA Service Centres.
	Electric failure.	→ Send the pump to one of our GARDENA Service Centres.

Attention!

Repairs on electrical parts should only be done by our GARDENA Service Centres.

If you have any problems with your pump, please contact our Service.

7. Storage

Wintering/Storage:

Empty your Dual Pump before the first frost sets in.

1. Hold the pump diagonally and drain the water from the pump out of the inlet side.
2. Store your Dual Pump in a place that is protected from frost.

8. Accessories

GARDENA Suction Hoses Kink- and vacuum-resistant, sold by the metre with 19 mm (3/4") or 25 mm (1") diameter without fittings or in fixed length, complete with fittings.

GARDENA Suction Hose Fittings		• Art. no. 1723 / 1724
GARDENA Suction Filter with Backflow Preventer	To equip suction hoses sold by the metre.	• Art. no. 1726 / 1727 / 1728
GARDENA Pump Preliminary Filter	Recommended for pumping sandy liquids.	• Art. no. 1730 / 1731
GARDENA Electronic Manometric Switch	Automatically cuts in and out the pump depending on the current operating pressure. With dry-running safety.	• Art. no. 1739
GARDENA Dry-Running Safety	Prevents the pump from damages in case of missing liquid.	• Art. no. 1741

9. Technical Data

5000/3 SGP (Art. 1471)	
Rated power	750 W
Max. delivery capacity	5,200 l/h
Max. pressure	3.3 bar
Max. delivery head	33 m
Max. self-priming suction height	8 m
Perm. internal pressure (delivery side)	6 bar
Voltage	230 V AC
Frequency	50 Hz
Weight	7.8 kg
Noise level L_{WA}^1	66 dB (A)

1) Measuring method according to Directive 2000/14/EC

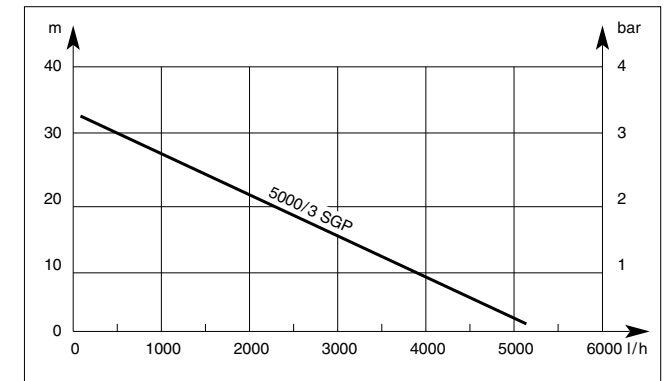
Performance characteristics

10. Service

Warranty

GARDENA guarantees this product for 2 years (from date of purchase). This guarantee covers all serious defects of the unit that can be proved to be material or manufacturing faults. Under warranty we will either replace the unit or repair it free of charge if the following conditions apply:

- The unit must have been handled properly and in keeping with the requirements of the operating instructions.
- Neither the purchaser or a non-authorized third party have attempted to repair the unit.

The impeller is a wearing part and is not covered by the guarantee. This manufacturer's guarantee does not affect the user's existing warranty claims against the dealer/seller.

If a fault occurs with your Dual Pump, please return the faulty unit together with a copy of the receipt and a description of the fault, with postage paid to one of the GARDENA Service Centres listed on the back of these operating instructions.

Product Liability

We expressly point out that, in accordance with the product liability law, we are not liable for any damage caused by our units if it is due to improper repair or if parts exchanged are not original GARDENA parts or parts approved by us, and, if the repairs were not carried out by a GARDENA Service Centre or an authorised specialist. The same applies to spare parts and accessories.

EU Certificate of Conformity

The undersigned GARDENA Kress + Kastner GmbH · Hans-Lorenser-Str. 40 · D-89079 Ulm hereby certifies that, when leaving our factory, the unit indicated below is in accordance with the harmonised EU guidelines, EU standards of safety and product specific standards.

This certificate becomes void if the unit is modified without our approval.

Description of the unit:	Dual Pump
Type:	5000/3 SGP
Art. No.:	1471
EU directives:	Machinery Directive 98/37/EC Electromagnetic Compatibility 89/336/EC Low Voltage Directive 73/23/EC Directive 93/68/EC Directive 2000/14/EC
Harmonised European standards:	EN 292-1 EN 292-2 EN 60335-1 EN 60335-2-41
Noise level:	measured 66 dB (A) guaranteed 69 dB (A)
Year of CE marking:	2002

Ulm, 09.07.2002



Thomas Heint
Technical Dept. Manager

Deutschland

GARDENA Kress + Kastner GmbH
GARDENA Service
Hans-Lorenser-Straße 40
D-89079 Ulm
Produktfragen: (07 31) 490-123
Reparaturen: (07 31) 490-290

Argentina

Argensem S.A.
Venezuela 1075
(1618) El Talar - Buenos Aires

Australia

NYLEX Consumer Division
76-88 Mills Road
P.O. Box 722
Braeside 3195
Melbourne, Victoria

Austria

GARDENA Österreich Ges. m.b.H.
Stettnerweg 11-15
2100 Korneuburg

Belgium

MARKT (Belgium) NV/SA
Sterrebeekstraat 163
1930 Zaventem

Brazil

M. Cassab
Av. das Nações Unidas, 20.882
Santo Amaro, CEP 04795-000
São Paulo - S.P.

Bulgaria / България

ДЕНЕКС ООД
Бул. "Г.М.Димитров" 16 ет.4
София 1797

Canada

GARDENA Canada Ltd.
100, Summerlea Road
Brampton, Ontario
Canada L6T 4X3

Chile

Antonio Martinic Y CIA. LTDA.
Gilberto Fuenzalida 185 Loc.
Las Condes - Santiago de Chile

Costa Rica

Compania Exim
Euroiberoamericana S.A.
350 Sur del Automercado
Los Yoses
San Pedro

Cyprus

FARMOKIPIKI LTD
P.O. Box 7098
74, Digeni Akrita Ave.
1641 Nicosia

Czech Republic

GARDENA spol. s.r.o.
Řípská 20a, č.p. 1153
62700 Brno

Denmark

GARDENA Danmark A/S
Naverland 8
2600 Glostrup

Finland

Habitec Oy
Martinkyläntie 52
01720 Vantaa

France

GARDENA France
Service Après-Vente
BP 50080
95948 ROISSY CDG Cedex

Great Britain

GARDENA UK Ltd.
27-28 Brenkley Way
Blezard Business Park
Seaton Burn
Newcastle upon Tyne NE13 6DS

Greece

Agrokip G. Psomadopoulos & Co.
33a, Ifestou str.
Koropi 194 00
Athens

Hungary

GARDENA Magyarország Kft.
Késmárk utca 22
1158 Budapest

Iceland

Heimilistaeki hf
Saetun 8
P.O. Box 5340
125 Reykjavik

Republic of Ireland

Michael McLoughlin & Sons
Hardware Limited
Long Mile Road
Dublin 12

Italy

GARDENA Italia S.r.l.
Via Donizetti 22
20020 Lainate (Mi)

Japan

KAKUDAI Mfg. Co. Ltd.
1-4-4, Itachibori Nishi-ku
Osaka 550

Luxembourg

Magasins Jules Neuberg
Grand Rue 30
Case Postale No. 12
Luxembourg 2010

Netherlands

GARDENA Nederland B.V.
Postbus 50176
1305 AD ALMERE

Neth. Antilles

Jonka Enterprises N.V.
Sta. Rosa Weg 196
P.O. Box 8200
Curaçao

New Zealand

NYLEX New Zealand Limited
Private Bag 94001
South Auckland Mail Centre
10 Offenhauser Drive
East Tamaki, Manukau

Norway

GARDENA Norge A/S
Postboks 214
2013 Skjetten

Poland

GARDENA Polska Sp. z o.o.
Szymanów 9 d
05-532 Baniocza

Portugal

MARKT (Portugal), Lda.
Recta da Granja do Marquês
Edif. GARDENA
Algueirão
2725-596 Mem Martins

Russia / Россия

АО АМИДА ТТЦ
ул. Мосфильмовская 66
117330 Москва

Singapore

Variware
Holland Road Shopping Centre
227-A 1st Fl., Unit 29
Holland Avenue
Singapore 1027

Slovenia / Croatia

Silk d.o.o. Trgovina
Brodišče 15
1236 Trzin

South Africa

GARDENA South Africa (Pty.) Ltd.
P.O. Box 11534
Vorna Valley 1686

Spain

ANMI Andreu y Miriam S.A.
Calle Pere IV, 111
08018 Barcelona

Sweden

GARDENA Svenska AB
Box 9003
20039 Malmö

Switzerland

GARDENA Kress + Kastner AG
Bitziberg 1
8184 Vachenbülach

Ukraine / Украина

АОЗТ АЛЬЦЕСТ
ул. Гайдара 50
г. Киев 01033

Turkey

Dost Diş Ticaret Müessesilik A.Ş.
Yeşilbağlar Mah. Başkent
Cad. No. 26
Pendik - İstanbul

USA

GARDENA
3085 Shawnee Drive
Winchester, VA 22604

1471-20.960.02/0021
© GARDENA Kress + Kastner GmbH
Postfach 27 47, D-89070 Ulm
<http://www.gardena.com>