

12 V WP 600 Art. 7850
WP 1200 Art. 7856

D Gebrauchsanweisung

Wasserspielpumpe 12 V

GB Operating Instructions

Fountain Pump 12 V

F Mode d'emploi

Pompe pour jets d'eau 12 V

NL Gebruiksaanwijzing

Waterspelpomp 12 V

S Bruksanvisning

Fontän Pump Set 12 V

I Istruzioni per l'uso

Pompa per giochi d'acqua 12 V

E Manual de instrucciones

Bomba para juegos de agua 12 V

DK Brugsanvisning

Springvandspumpe Sæt 12 V

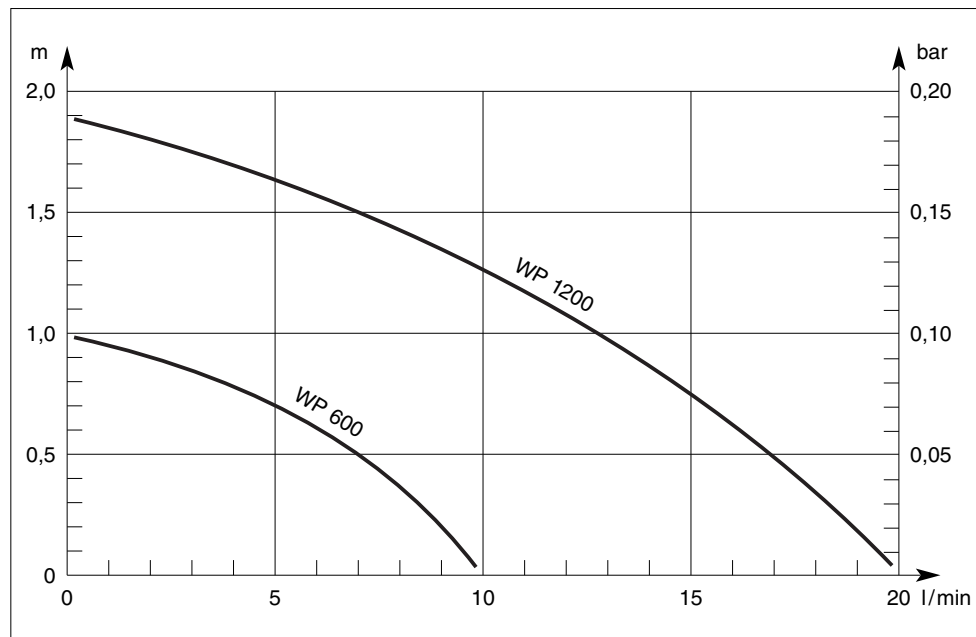

D

Bitte lesen Sie diese
Gebrauchsanweisung
vor Inbetriebnahme
Ihres Gerätes sorgfältig.

Gebrauchsanweisung Seite
3 - 10

GB

Please read these operating
instructions carefully before
using the unit.

Operating instructions Page
11 - 17

F

Nous vous remercions de
bien vouloir lire attentive-
ment ce mode d'emploi
avant l'utilisation de votre
pompe.

Mode d'emploi Page
18 - 24

NL

Lees deze gebruiksaanwij-
zing voor ingebruikname
van het apparaat zorgvuldig
door.

Gebbruiksaanwijzing Pagina
25 - 31

S

Läs igenom bruksanvisnin-
gen noggrant innan Du tar
Din GARDENA Pump i bruk.

Bruksanvisning Sida
32 - 37

I

Prima di mettere in uso
la nuova pompa, leggere
attentamente le istruzioni.

Istruzioni per l'uso pagina
38 - 44

E

Antes de la puesta en
marcha del aparato, acon-
sejamos una atenta lectura
del presente manual de
instrucciones.

Manual de instrucciones Página
45 - 51

DK

Læs venligst brugsanvis-
ningen omhyggeligt igen-
nem.

Brugsanvisning Side
52 - 58

GARDENA Fountain Pump

WP 600, 12 V / WP 1200, 12 V

Welcome to GARDENA aquamation ...



Please read these operating instructions carefully and observe the notes given.

Use the instructions to familiarise yourself with the equipment, the operating controls, their correct use, and the notes on safety.

⚠ For safety reasons, children under 16 as well as persons not familiar with these operating instructions should not use this pump.

Keep these operating instructions in a safe place.

The Applications Range of Your Pump

Intended purpose

GARDENA Fountain Pumps have been designed for private use. They are not designed for operating watering tools and systems. The pumps may be used indoors as well as outdoors. The same applies to the transformers.

Attention

⚠ GARDENA Fountain Pumps have not been designed for constant use in the industrial sector. Corrosive, easily combustible, aggressive or explosive substances (e.g. petrol, petroleum, nitro thinner) as well as salt-water or food / drinking water must not be pumped.



For Your Safety

Operating the Pump

The transformer should be operated via a residual current device with a residual current rating of ≤ 30 mA (DIN VDE 0100-702 and 0100-738). The pump must be placed on solid, even ground. Please ask your electrician for his advice.

Mains power cables

Mains power cables should not have a smaller cross-section than a rubber sheathed cable of the designation H05 RNF. Extension cables must meet the requirements of DIN VDE 0620.

For Austria

In Austria power cables should correspond to ÖVE-EM 42, T 2 (2000)/1979 § 22 according to § 2022.1. According to this standard pumps used in swimming pools and ponds should only be operated via an isolating transformer. Please contact your electrician.

For Switzerland

In Switzerland mobile appliances which are used outdoors, must be connected via a residual-current device.

Visual check

Before operating the pump, look to see if there is any damage of the pump. A damaged pump must not be used. In case of damage, please have the pump checked by our GARDENA Service Centre or by an authorised electrician.

Check line voltage	Check line voltage. Data indicated on the type plate must match technical data of the mains supply.
Do not operate pump when there are people in the water	The pump must not be operated when there are people in the water.
Swimming pools and garden ponds	Swimming pools and garden ponds should be designed according to international and national design regulations. Please consult a professional electrician.
Do not use power cable to carry the pump	Do not use the power cable to carry the pump or to pull the plug out of the socket. Protect the power cable from heat, oil and sharp edges.
Disconnect plug	Please unplug the pump after operation and before carrying out any maintenance works.
Temperature of the liquid used	The temperature of the liquid used must not be below 4 °C or above 35 °C.
Wear and reduced output	Sand and other abrasive substances in the liquid cause increased wear and reduce the output of the pump.
Caution! 12 V low voltage	GARDENA pumps and plug connections have been designed exclusively for the use with 12 V low voltage. When connected to 230 V your life is at risk! Operate the pump only with the delivered transformer.
Do not expose the transformer to sunlight	Do not expose the transformer to direct sunlight.
To place the transformer	Ensure that the transformer is positioned in a place safe from flooding and at least 2 m away from the edge of the pond.
Observe local noise prevention regulations	Please observe the local noise prevention regulations.

Applications: Examples – System Extensions – Product Recommendations

Water jets for 26,5 mm (G 3/4) thread connections

→ Example for application:
Water jets may be integrated into water features.

Model	Art. No.	Cascade	Water Bell	Foaming Jet Spray	Water Fleur-de-Lis	Water-fall	Cascade Rotating
		7814*	7816	7818	7820	7822	7823
WP 600, 12 V	7850	×	×	×	—	—	—
WP 1200, 12 V	7856	×	×	×	×	×	×

* contained in delivery volume

Adaptable lamps

→ Example for application:
Underwater lighting of water jets and pond edges.

→ Products:
GARDENA Underwater Light Art. No. 7951
GARDENA *lightline* Transformers

Light / Fountain Nozzle

→ Example for application:
For installation in ponds and fountains.

→ Product:
GARDENA Light/Fountain Nozzle Art. No. 7953

Remote control

→ Example for application:
For operating water jets from the comfort of your patio or your living room.

→ Products:
GARDENA Remote Control Set Art. No. 7874
GARDENA Remote Control Socket Art. No. 7875

Pond aeration

→ Example for application:
To aerate the pond.

→ Product:
GARDENA Pond Aerator Art. No. 7936

Filling the filter tank with zeolith

Zeolith fulfils the following functions:

- Filters the water (→ protection for the pump).
- Bonds with excessive nutrients and causes their decomposition by bacteria (→ Ion exchange and the bonding of e.g. nitrate).
- Helps to keep the pond clean and maintain the biological balance.
- Provides stability for the pump

GARDENA Zeolith, 1 l Art. No. 7914
GARDENA Zeolith, 5 l Art. No. 7915

Note:

To ensure the zeolith functions correctly, we recommend you replace or clean it every 6 months (e.g. in salt water).

Information

- Always unplug the pump first before working on it.
- Before assembling system extensions first unscrew the pre-assembled cascade and if necessary also the telescopic tube of the pump and then screw one of the water jets on again (→ the ball-and-socket joint ensures that the water jet is vertical).
- Follow the Safety and Assembly Information attached to the operating instructions.

Operation

Installing the pump

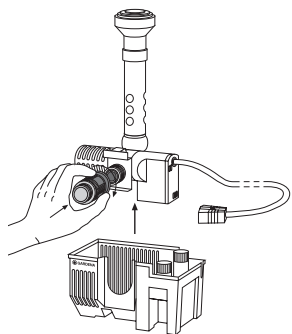

1. Remove the pump from the filter basket and screw the regulator supplied onto the second opening of the pump up to the limit stop (→ max. delivery capacity on the vertical outlet). Then replace the pump in the filter basket.
2. Put the pump on a stable base to ensure that the upper edge of the filter tank is completely immersed in water.

Pay attention to minimum water depth

Finding a location for the transformer

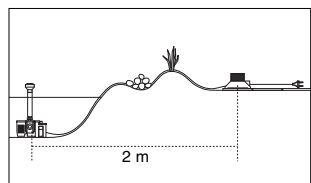

Please note the maximum submersion depth (see "Technical Data").

GARDENA *lightline* Transformers are licensed for outdoor use.

- You may attach them to the ground or the wall.
- When attaching to the wall, please take care that the connection sockets are pointing towards the ground.
- When attaching to the ground, please take care that the transformer is not exposed to direct rainfall or to a mechanical hazard.

Starting the pump

Put the plug connection into a free socket of the transformer and connect the power cable of the transformer with a 230 V AC socket.

⚠ Caution! Pump will start running immediately!

Avoid dry operation

Avoid dry operation of the pump as dry running will produce undesirable heat and destroy the pump.

Horizontal or second outlet

- Loosen the regulator by turning it anti-clockwise until you achieve the desired water flow from the vertical pipe of the fountain/water feature.
- You may connect other terminals to the second outlet. For example, a separately installed water jet may be operated via the GARDENA light jet base, Art. No. 7886. If necessary fix the light jet base with two screws.

Information:

This significantly reduces the volume of the vertical water jet.

- If the max. delivery capacity of the second outlet is to be used then the vertical outlet should be closed with the end cap supplied.

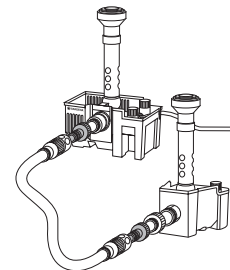

• Example:

Hose pipe connection with the GARDENA light jet base

We recommend the use of a 3/4" (19 mm) GARDENA pond hose pipe, Art. No. 7895, connected to with the GARDENA "Profi" Maxi-Flow-System with Tap Connector (Art. No. 2801 and 2802) and the GARDENA "Profi" Maxi-Flow-System Hose connectors (Art. No. 2817).

Care instructions

Cleaning the filter tank

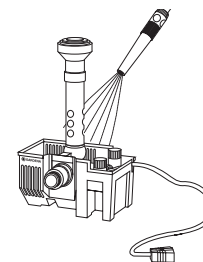

Filter tank and pump should be free from dirt particles!

How to clean:

- Pull the plug connections out of the transformer and disconnect its power plug!
- Remove the pump from the water.
- If necessary remove the gravel.
- Clean the pump and the filter using a water jet.
- If there are deposits of dirt inside the pump then dismantle the casing (→ see „Dismantling“) and carefully clean the interior fittings with water.

Information: Do not use any hard objects or strong detergents!

Blocked feed impeller

If the feed impeller becomes blocked, the pump and the filter should be cleaned (see above).

Dismantling

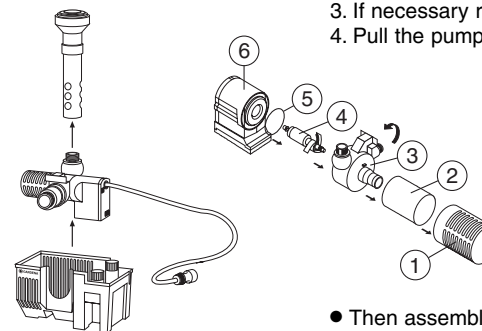

1. Pull the plug connections out of the transformer and disconnect its power plug!
2. Remove the pump from the water.
3. If necessary remove the gravel.
4. Pull the pump pointing vertically upwards out of the filter tank.
5. Pull the suction filter casing ① forwards and remove it.
6. Remove the foam filter ② from the suction piece of the pump.
7. Turn the pump casing ③ to the left to the limit stop and then pull it straight towards the front and remove it! Do not tilt!
8. Pull the feed impeller ④ out of the motor casing ⑥.

- Then assemble all the fittings reversing the order and direction in which they were dismantled. Please take care that the seal ring ⑤ is properly re-fitted.

- Make sure while assembling that you attach the pump casing with the pressure joint being cated, press it firmly and then turn it straight to the right.
- Observe the markings.

Storage

Where to store



⚠ The pump should be stored out of the reach of children.

1. Remove the pump from the pond and store away from frost before the first frost sets in.
2. Clean and check the pump carefully.
3. Store the pump in a container filled with water.
The mains plug must not be submerged.

Information

Complaints/Repairs

If you have any problems with your Fountain Pump, please contact our Service or return the defective unit together with a short description of the problem – in case of guarantee, with the warranty card duly completed and signed – postage paid to one of the GARDENA Service Centres listed on the back of this leaflet.

Product liability

We expressly point out that, in accordance with the product liability law, we are not liable for any damage caused by our units if it is due to improper repair or if parts exchanged are not original GARDENA parts or parts approved by us, and, if the repairs were not carried out by a GARDENA Service Centre or an authorised specialist. The same applies to spare parts and accessories.

Technical Data

Type	WP 600, 12 V	WP 900, 12 V
Art. No.	7850	7856
Rated power	5 W	15 W
Flow	10 l/min	20 l/min
Max. delivery head	1,0 m	1,8 m
Max. submersion depth	1.0 m	2.0 m
Power cable	10 m H05 RNF	10 m H05 RNF
Fitting	26.5 mm (G 3/4) male thread	26.5 mm (G 3/4) male thread
Max. media temperature	35 °C	35 °C
Mains voltage	230 V	230 V
Frequency	50 Hz AC	50 Hz AC
Noise level L_{WA} ¹⁾	48 dB(A)	48 dB(A)

1) Measuring method according to EN 60335-1

EU Certificate of Conformity

The undersigned

GARDENA Kress + Kastner GmbH · Hans-Lorenser-Str. 40 · D-89079 Ulm

hereby certifies that, when leaving our factory, the units indicated below are in accordance with the harmonised EU guidelines, EU standards of safety and product specific standards.

This certificate becomes void if the units are modified without our approval.

Description of the units:

Fountain Pumps

Type:

WP 600, 12 V / WP 900, 12 V

Art. No.:

7850 / 7856

EU directives:

Machinery Directive 98/37/EC

Electromagnetic Compatibility

89/336/EC

Low Voltage Directive

73/23/EC

Directive 93/68/EC

Harmonised

European standards:

EN 292-1

EN 292-2

EN 60335-1

EN 60335-2-41

Year of CE marking:

1999

Ulm, 01.06.1999

Thomas Heintl
Technical Dept. Manager

Guarantee

GARDENA guarantees this product for 3 years (from date of purchase). This guarantee covers all serious defects of the unit that can be proved to be material or manufacturing faults. Under warranty we will either replace the unit or repair it free of charge if the following conditions apply:



- The unit must have been handled properly and in keeping with the require-

ments of the operating instructions. Neither the purchaser nor a non-authorised third party have attempted to repair the unit.

Parts subject to wear (e.g. feed impeller) are excluded from this guarantee.

This manufacturer's guarantee does not affect the user's existing warranty claims against the dealer/seller.

In the event of a fault, please send the defective unit together with the receipt and a description of the fault, postage paid, to one of the GARDENA Service Centres on the back of this page.

Garantiekarte	Wasserspielpumpe	WP 600, 12 V 
Warranty Card	Fountain Pump	
Bon de garantie	Pompe pour jets d'eau	WP 1200, 12 V 
Garantiekkaart	Waterspelpomp	
Garantikort	Fontän Pump Set	
Certificato di garanzia	Pompa per giochi d'acqua	
Tarjeta de garantía	Bomba para juegos de agua	
Garantibevis	Springvandspumpe	

Wurde gekauft am:	Händlerstempel
Was purchased on:	Dealer's stamp / Receipt
Achetée le (date et lieu d'achat) :	Cachet du revendeur
Werd gekocht op:	Stempel van de handelaar
Försäljningsdatum:	Återförsäljarens stämpel
Data di acquisto:	Timbro del rivenditore
Fecha de la compra:	Sello del comerciante
Købsdato:	Firmastempel

Beanstandung:
 Reasons for complaint:
 Défaut constaté :
 Klacht:
 Reklamation:
 Difetto riscontrato:
 Reclamación :
 Reklamation:



Deutschland

GARDENA Kress + Kastner GmbH
GARDENA Service
Hans-Lorensen-Straße 40
D-89079 Ulm
Produktfragen: (07 31) 490 - 123
Reparaturen: (07 31) 490 - 290

Argentina

Argensem S.A.
Venezuela 1075
(1618) El Talar - Buenos Aires

Australia

NYLEX Corporation Ltd.
25-29 Nepean Highway
P.O. Box 68
Mentone, Victoria 3194

Austria

GARDENA Österreich Ges. m.b.H.
Stettnerweg 11-15
2100 Korneuburg

Belgium

MARKT (Belgium) NV/SA
Sterrebeekstraat 163
1930 Zaventem

Brazil

M. Cassab
Av. das Nações Unidas, 20.882
Santo Amaro, CEP 04795-000
São Paulo - S.P.

Bulgaria / България

ДЕНЕКС ООД
бул. „Черни връх“ 43
София 1407

Canada

GARDENA Canada Ltd.
100, Summerlea Road
Brampton, Ontario
Canada L6T 4X3

Chile

Antonio Martinic Y CIA. LTDA.
Gilberto Fuenzalida 185 Loc.
Las Condes - Santiago de Chile

Costa Rica

Compania Exim
Euroiberoamericana S.A.
350 Sur del Automercado
Los Yoses
San Pedro

Cyprus

FARMOKIPIKI LTD
P.O. Box 7098
74, Digeni Akrita Ave.
1641 Nicosia

Czech Republic

GARDENA spol. s.r.o.
Ripská 20
62700 Brno

Denmark

GARDENA Danmark A/S
Naverland 8
2600 Glostrup

Finland

Habitec Oy
Martinkyläntie 52
01720 Vantaa

France

GARDENA France
Service Après-Vente
BP 50080
95948 ROISSY CDG Cedex

Great Britain

GARDENA UK Ltd.
27-28 Brenkley Way
Blezard Business Park
Seaton Burn
Newcastle upon Tyne
NE13 6DS

Greece

Agrokip G. Psomadopoulos & Co.
20, Lykourgou str.
Kallithea - Athens

Hungary

GARDENA Magyarország Kft.
Késmárk utca 22
1158 Budapest

Iceland

Heimilistaeki hf
Saetun 8
P.O. Box 5340
125 Reykjavik

Republic of Ireland

Michael McLoughlin & Sons
Hardware Limited
Long Mile Road
Dublin 12

Italy

GARDENA Italia S.r.l.
Via Donizetti 22
20020 Lainate (Mi)

Japan

KAKUDAI Mfg. Co. Ltd.
1-4-4, Itachibori Nishi-ku
Osaka 550

Luxembourg

Magasins Jules Neuberg
Grand Rue 30
Case Postale No. 12
Luxembourg 2010

Netherlands

MARKT (Holland) BV
Postbus 219
1380 AE Weesp

Neth. Antilles

Jonka Enterprises N.V.
Sta. Rosa Weg 196
P.O. Box 8200
Curaçao

New Zealand

NYLEX New Zealand Limited
Private Bag 94001
South Auckland Mail Centre
10 Offenhauser Drive
East Tamaki, Manukau

Norway

GARDENA Norge A/S
Postboks 214
2013 Skjetten

Poland

GARDENA Polska Sp. z o.o.
Szymanów 9 d
05-532 Baniocza

Portugal

MARKT (Portugal), Lda.
Recta da Granja do Marquês
Edif. GARDENA
Algueirão
2725-596 Mem Martins

Russia / Россия

АО АМИДА ТТЦ
ул. Мосфильмовская 66
117330 Москва

Singapore

Variware
Holland Road Shopping Centre
227-A 1st Fl., Unit 29
Holland Avenue
Singapore 1027

Slowenia / Croatia

Silk d.o.o. Trgovina
Brodišče 15
1236 Trzin

South Africa

GARDENA South Africa (Pty.) Ltd.
P.O. Box 11534
Vorna Valley 1686

Spain

ANMI Andreu y Miriam S.A.
Calle Pere IV, 111
08018 Barcelona

Sweden

GARDENA Svenska AB
Box 9003
20039 Malmö

Switzerland

GARDENA Kress + Kastner AG
Bitziberg 1
8184 Bachenbülach

Ukraine / Украина

АОЗТ АЛЬЦЕСТ
ул. Гайдара 50
г. Киев 01033

Turkey

Dost Diş Ticaret Mümesillik A.Ş.
Yeşilbağlar Mah. Başkent
Cad. No. 26
Pendik - İstanbul

USA

GARDENA
3085 Shawnee Drive
Winchester, VA 22604

7850-20.960.05/0001
GARDENA Kress + Kastner GmbH
Postfach 27 47, D-89070 Ulm
<http://www.gardena.de>

T3055126181E/Id.22304/07H