



Art. 19035

en **Operator's manual**
smart Irrigation Control

GARDENA smart Irrigation Control

1. SAFETY WARNINGS	4
2. ASSEMBLY	6
3. INSTALLATION	9
4. OPERATION	20
5. MAINTENANCE	23
6. STORAGE	23
7. TROUBLESHOOTING	24
8. TECHNICAL DATA	26
9. ACCESSORIES/SPARE PARTS	27
10. SERVICE	27
11. DISPOSAL	28
12. TRADEMARK ATTRIBUTION	29

Translation of the original instructions.



This product may be used under supervision, or if instruction regarding the safe use of the product has been provided and the resulting dangers have been understood, by children aged 8 and above, as well as by persons with physical, sensory or mental disabilities or a lack of experience and knowledge. Children must not be allowed to play with the product. Cleaning and user maintenance must not be performed by children without supervision. The use of this product by young people under the age of 16 is not recommended.

Intended use:

The **GARDENA smart Irrigation Control** is intended for private use in domestic and hobby gardens, to control sprinklers and irrigation systems. It can be used for automatic watering during holidays. It is not intended for use in an indoor irrigation system.

The **GARDENA smart Irrigation Control** is part of a garden irrigation system and can only be programmed together with the **GARDENA smart Gateway**.

The **GARDENA smart Irrigation Control** is configured via the **GARDENA smart App** and controls the watering. Sprinklers, a sprinkler system or a drip head watering system can be used for watering.

The **GARDENA smart Irrigation Control** carries out watering fully automatically according to the set program and can therefore also be used during holidays.



DANGER!

Risk of injury!

The product must not be used for industrial purposes or in conjunction with chemicals, foodstuffs, easily flammable and explosive materials.

1. SAFETY WARNINGS



Important!

Read the operator's manual carefully before use and keep for future reference.

1.1 Explanation of the symbols:



Read operator's manual.

1.2 Safety warnings:



DANGER! Cardiac arrest!

This product makes an electromagnetic field while it operates. This field can affect the functioning of active or passive medical implants and cause serious or fatal injuries (e.g. pacemakers).

- **Consult your physician and the manufacturer of your implant before using this product.**
- **After using the product, disconnect the mains plug from the mains socket.**



DANGER! Risk of suffocation!

Small parts can be easily swallowed. There is also a risk that the polybag can suffocate toddlers.

- **Keep toddlers away when you assemble the product.**



DANGER! Electric shock!

Risk of injury due to electric shock.

- **The product must be supplied through a residual current device (RCD) having a rated residual operating current not exceeding 30 mA.**

The product must only be operated with the 36 V (DC) power supply unit provided. Do not use an adapter.

Protect the 36 V (DC) power supply unit from moisture and direct sunlight when connected.

Install the Irrigation Control in a weatherproof location.

Check the power cord for damage before use.

The product must be used only for controlling commercially available 24 V (AC) valves. The electric power consumption per channel must

not exceed 500 mA (a GARDENA Irrigation Valve Art. 1278 requires 150 mA).

2. ASSEMBLY

2.1 Location of installation of the Irrigation Control:

The Irrigation Control is splash-proof. We recommend installing the Irrigation Control in a location protected from the weather.

2.2 Cable cross-section of the connection cable:

The maximum permissible distance between the product and the valve depends on the cross-section of the connection cable. For a distance of 30 m, the cross-section is 0.5 mm² and 0.75 mm² for a distance of 45 m. No more than 2 valves (except for the master valve) must be in operation at the same time.

The **GARDENA Connection Cable Art. 1280** has a cross-section of 0.5 mm² and is 15 m long.

This cable allows to connect up to 6 valves. For a waterproof connection of the cable, use the **GARDENA Cable Clip Art. 1282**.

2.3 To assemble the Irrigation Control on the wall:

Both screws and wall plugs are included in the scope of delivery.

The distance between the holes is 120 mm.



WARNING!
Risk of falling!

If you install the Irrigation Control at a height of more than 2.0 m, you risk falling to the ground during installation.

- Install the Irrigation Control at a height of 2.0 m maximum.
- Do not climb on a ladder or similar aid to install the Irrigation Control.
- Keep both feet firmly on the ground when mounting the Irrigation Control.

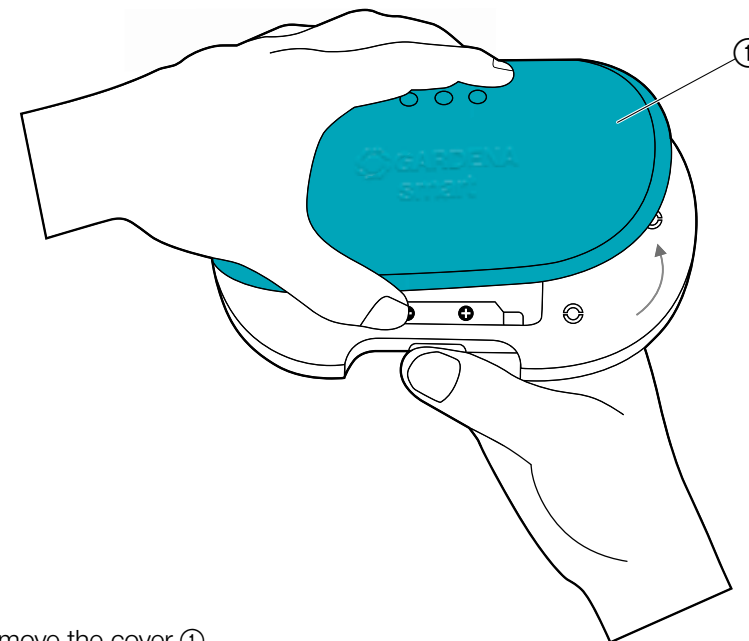

1. Remove the cover ①.

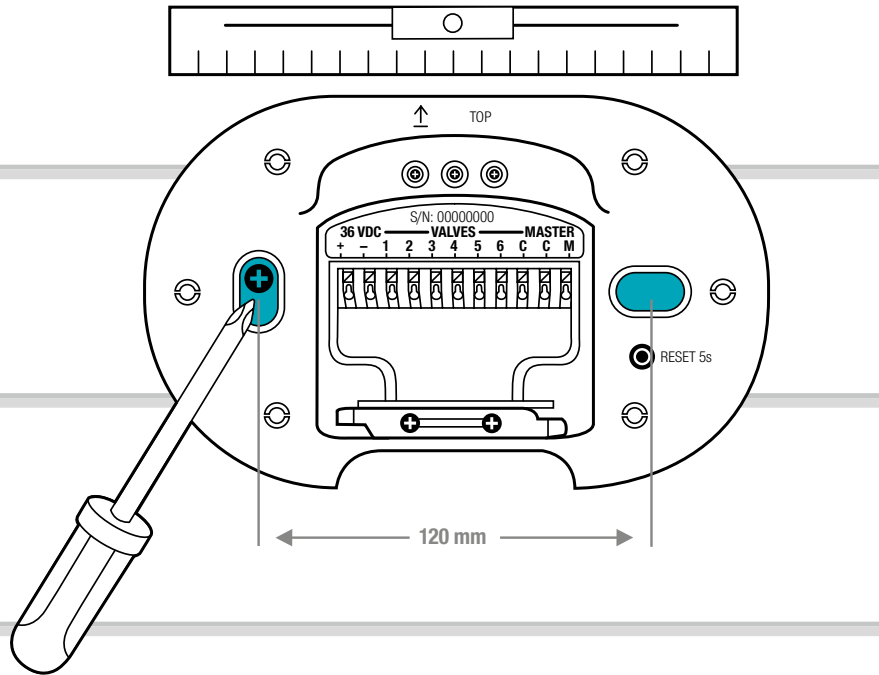

2. Mark the positions of the holes. To do this, hold the Irrigation Control horizontally against the wall and mark 2 holes at a distance of 120 mm.
3. Drill the holes and install the Irrigation Control at the wall using the 2 wall plugs and screws supplied.

NOTE:

The cables must be led downwards!

Pay attention to the cable lengths, especially during initial installation.

If you want to mount several Irrigation Controls, install them one above the other with a vertical distance of 150 mm.

The cable routing allows you to install up to 3 irrigation controls one above the other.

3. INSTALLATION

3.1 To remove the cable strain relief:

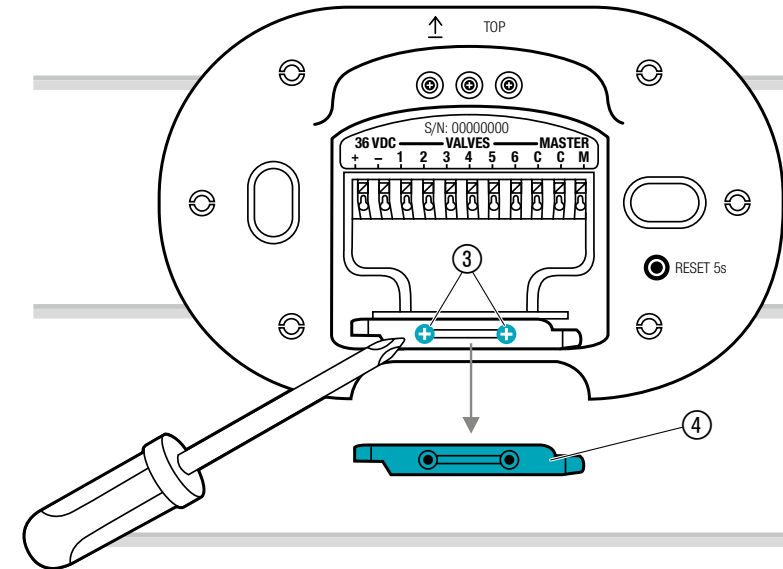

→ Loosen both screws ③ and remove the cable strain relief ④.

3.2 Connection overview:

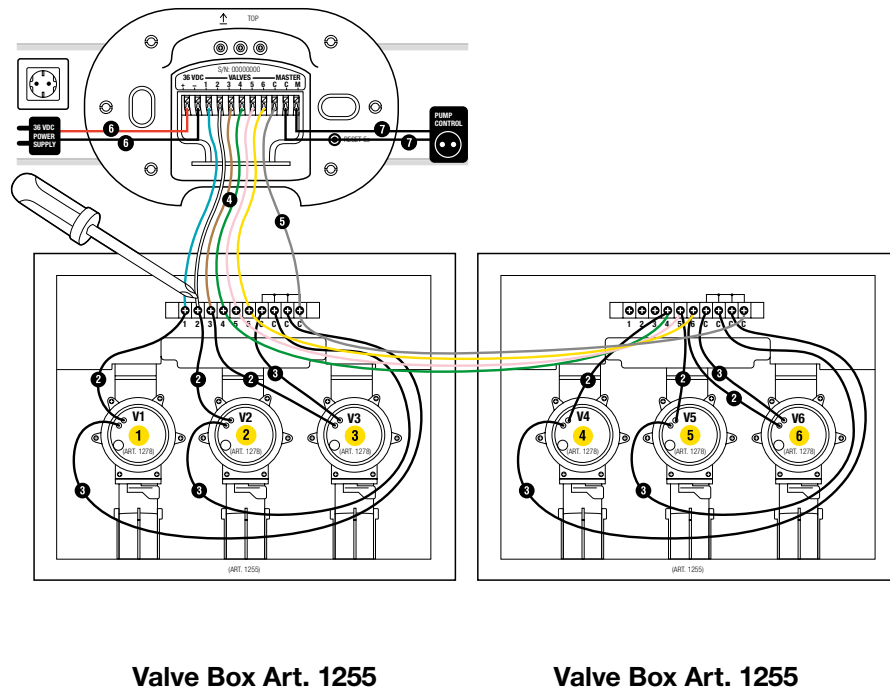

3.3 To connect the valves to the Valve Box:

Make sure that the terminal block has been correctly installed in the valve box.

1

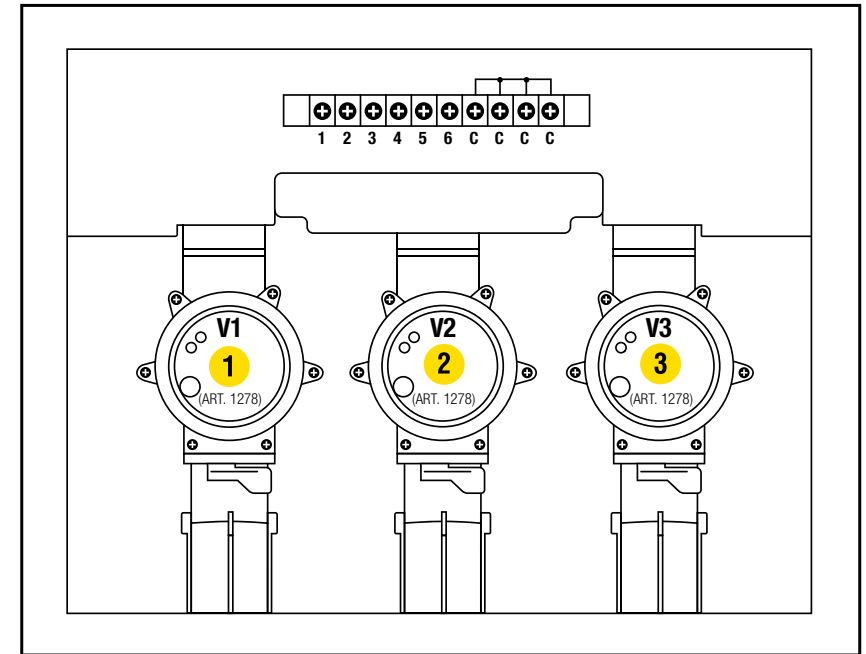

1. Label the valves (1 – 6) with the yellow stickers of the valve box.
This allows to clearly assign the signal cable terminals **VALVES 1 – 6** of the Irrigation Control to the valves.

2

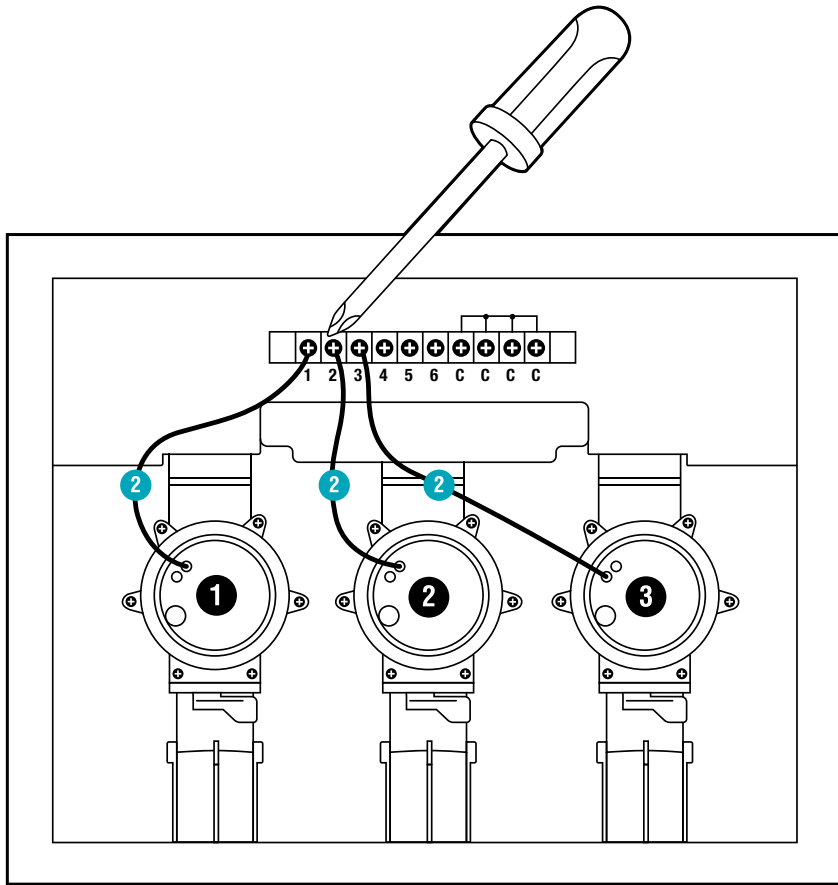

2. Connect a cable of the valve **V1** to the signal cable terminal **1** of the Valve Box.
3. Connect a cable of the valve **V2** to the signal cable terminal **2** of the Valve Box.
4. Connect a cable of the valve **V3** to the signal cable terminal **3** of the Valve Box.

3

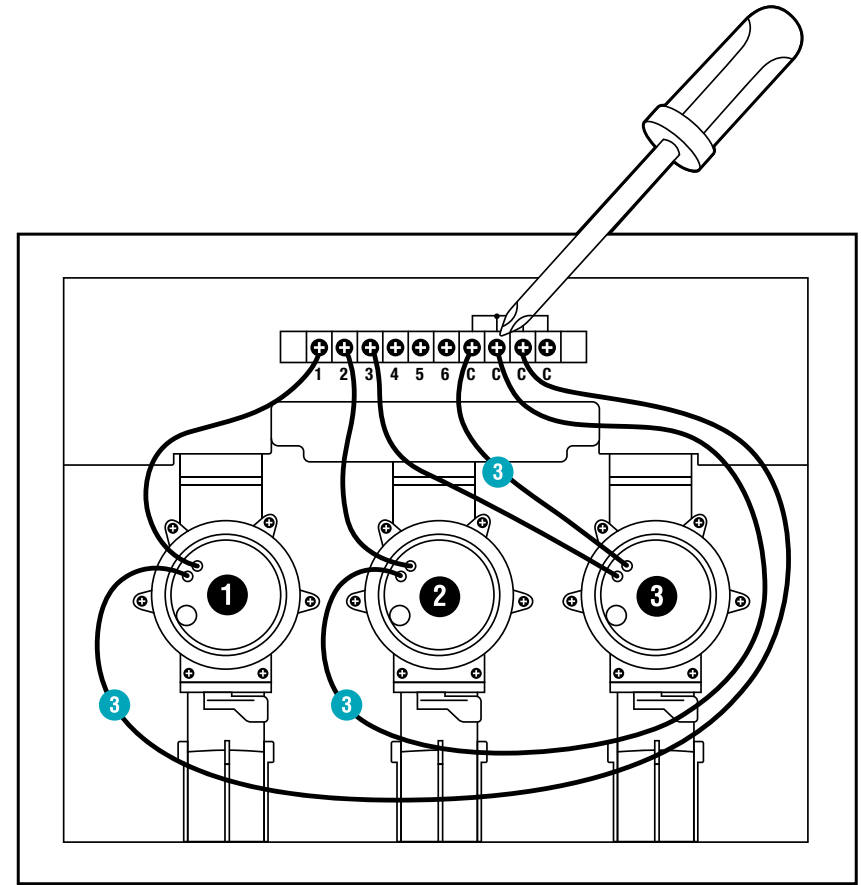

5. Connect the other cable of the valve **V1** to a signal cable terminal **C** of the Valve Box.
*All 4 signal cable terminals **C** are connected to each other and equivalent.*
6. Connect the other cable of the valve **V2** to a signal cable terminal **C** of the Valve Box.
7. Connect the other cable of the valve **V3** to a signal cable terminal **C** of the Valve Box.

3.4 To connect the Valve Box to the Irrigation Control:

Tip: Press down the signal cable terminal with your index finger, screwdriver or ballpoint pen to connect the cables.

With the **GARDENA Connection Cable Art. 1280** you can connect up to **6 valves** with the Irrigation Control.

4

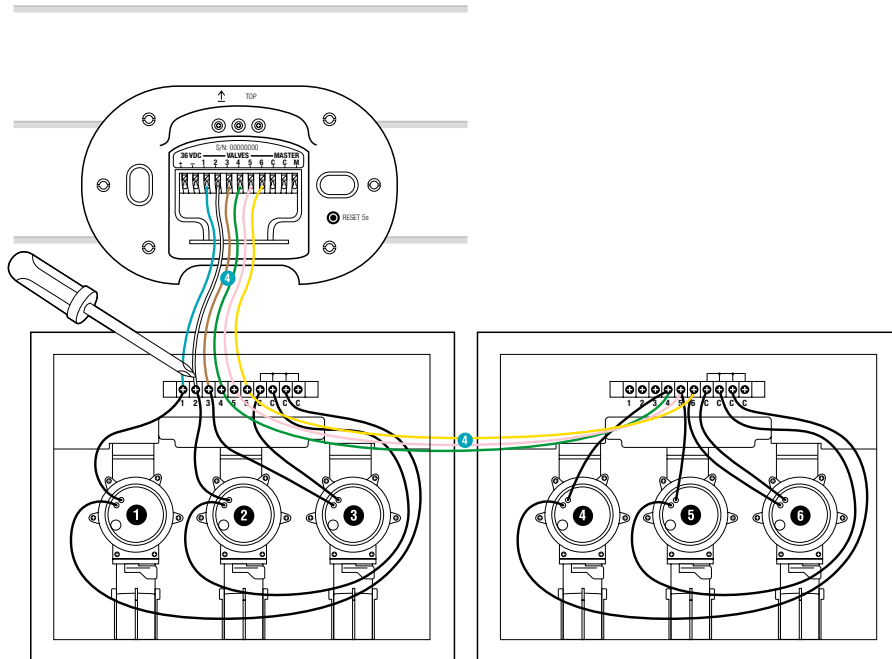

1. Connect the signal cable terminal **1** of the valve box to the signal cable terminal **VALVES 1** of the Irrigation Control.
2. Connect the signal cable terminal **2** of the valve box to the signal cable terminal **VALVES 2** of the Irrigation Control.
3. Connect the signal cable terminal **3** of the valve box to the signal cable terminal **VALVES 3** of the Irrigation Control.

5

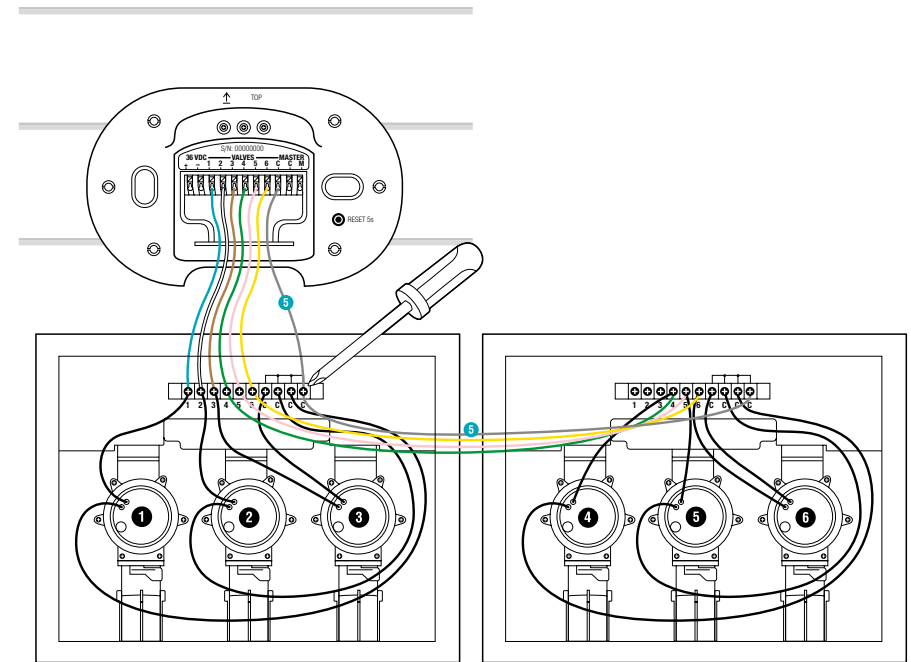

4. Connect one signal cable terminal **C** of the Valve Box to the blue signal cable terminal **C** of the Irrigation Control.

3.5 To connect the master valve:

Master Channel:

The master channel **M** is activated as soon as one of the valves is activated.
You can connect a central valve as master valve upstream of the other valves.

6

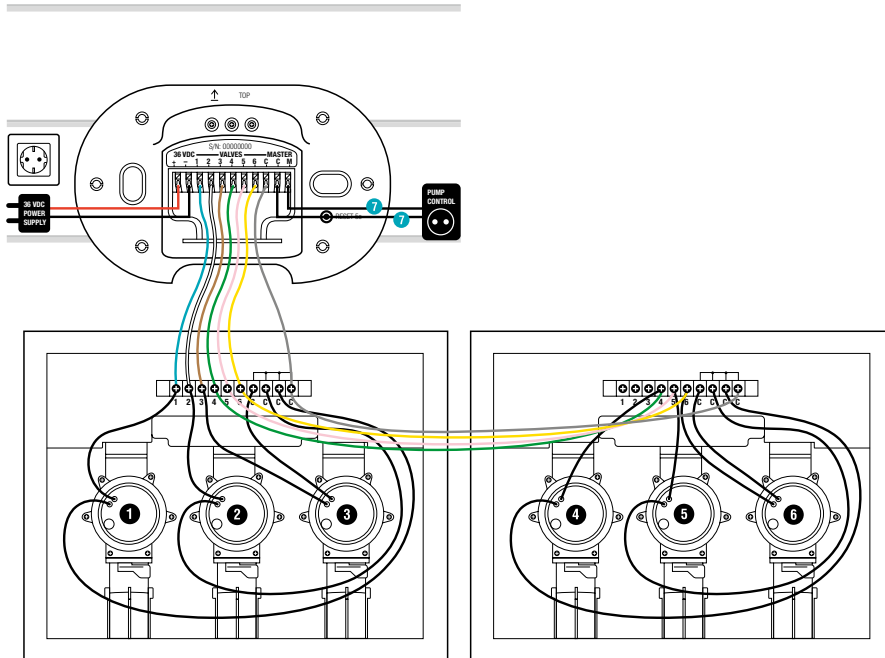

→ Connect both cables to the signal cable terminals **M** and **C** of the Irrigation Control (polarity does not have to be considered).

3.6 To connect the power supply:



CAUTION! Property damage!

The Irrigation Control is damaged if the power supply unit is connected to cable terminals other than the 36 V DC cable terminals.

→ Connect the power supply unit to the 36 V DC terminals only.



CAUTION! Property damage!

Damaging of the Irrigation Control system by short circuit.

→ Check all wiring before you plug in the power supply.

7

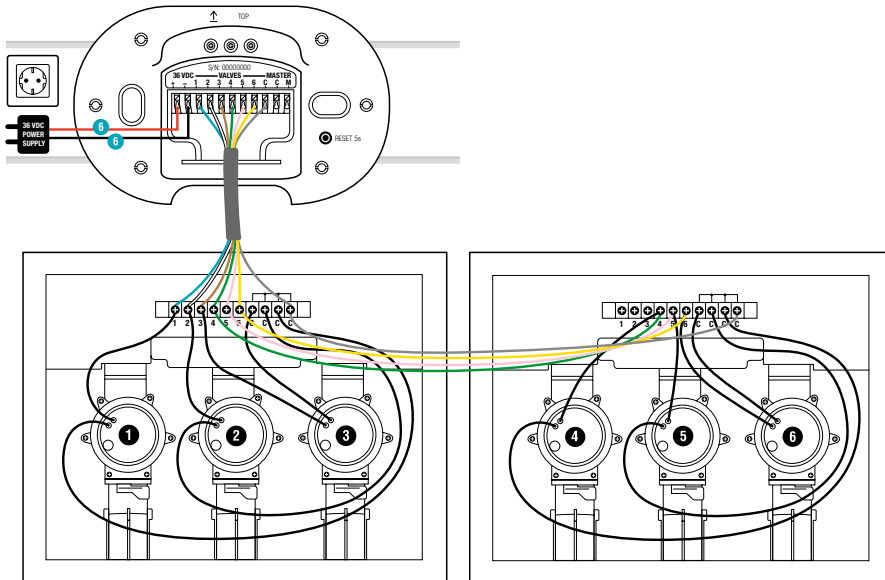

1. Connect the red cable to the red cable terminal and the black cable to the black cable terminal. (The polarity has to be considered.)
2. Plug the power supply unit into a socket.

3.7 To close the cover:

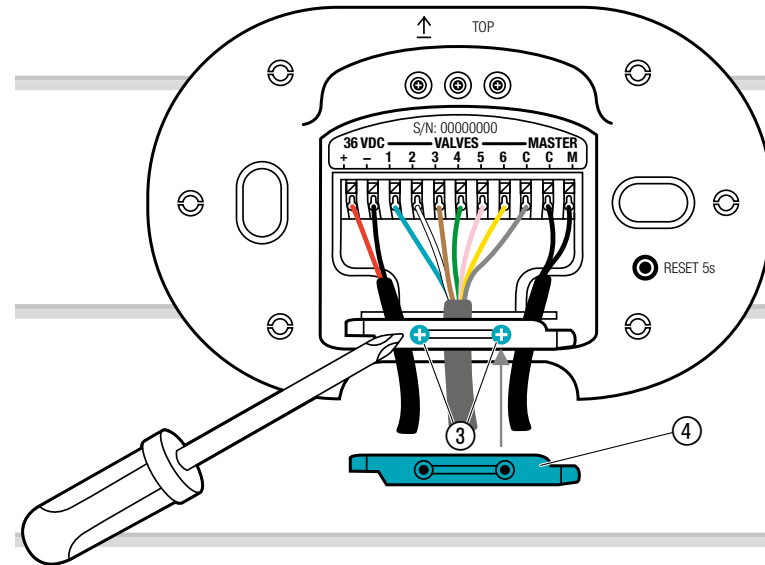

1. Attach the cable strain relief (4) and tighten the two screws (3).

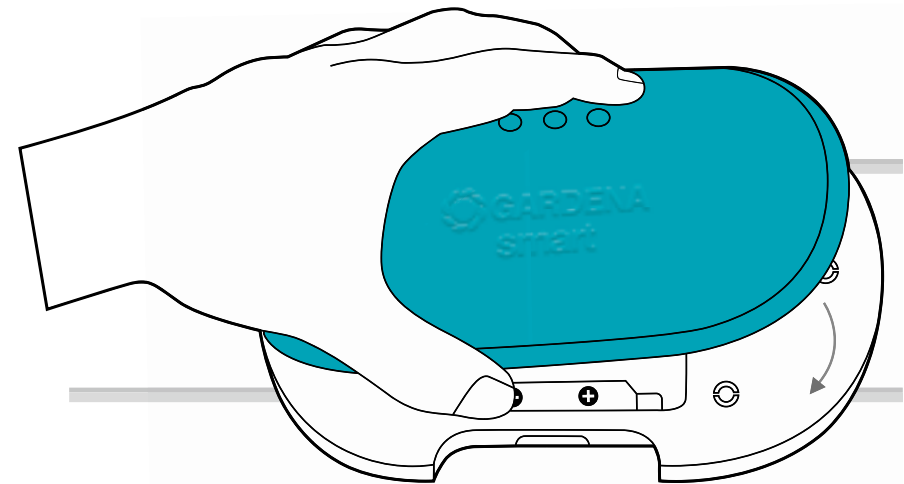

2. Push the cover onto the Irrigation Control.

4. OPERATION

4.1 LED Display:

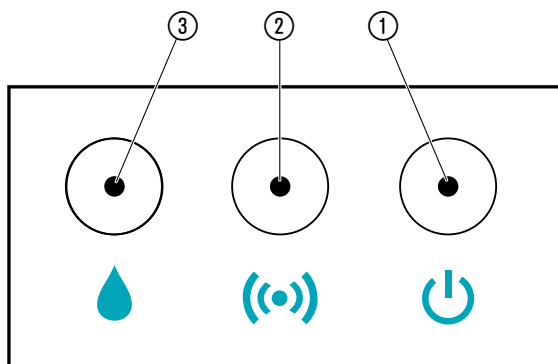

- ① **LED Power:**
Green: Power on
- ② **LED Connection display/Signal:**
Green flashing: While connecting
Green: Signal strength high
Yellow: Signal strength medium
Red: Signal strength low
Red flashing: Inclusion mode failed
- ③ **LED Active watering:**
Green: Active watering
Red flashing: Valve error (see 7. TROUBLESHOOTING)

4.2 To operate the Irrigation Control with the GARDENA smart App:

You can use the **GARDENA smart App** to control all **GARDENA smart system** products from anywhere at any time. The free **GARDENA smart App** is available on the App Store (Apple) and on Google Play.

For the integration, you need a **GARDENA smart Gateway** connected to the Internet. You can integrate all **GARDENA smart system** products via the app. To do so, follow the instructions in the app.

The following options to operate the Irrigation Control are available to you:

- According to the timings in the **GARDENA smart App**:
Watering days, start, duration
- As required in the **GARDENA smart App**:
Start and finish
- Operation via Amazon Alexa, Apple Home App (Siri) and Google Assistant

4.3 To perform a factory reset:

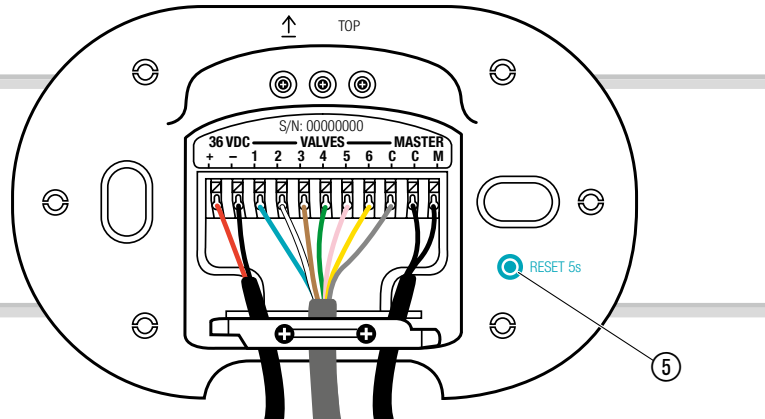

1. Push the Reset key ⑤ for a short time.
New connection.

– or –

2. Push and hold down the Reset key ⑤ for at least 5 seconds.
Cancel the existing connection and allows a new connection to be established, e.g. different Gateway.

5. MAINTENANCE

5.1 To clean the Irrigation Control:

Do not use caustic/abrasive cleaning agents.

→ Clean the Irrigation Control with a damp cloth (do not use solvent).

6. STORAGE

6.1 To put into storage:

The product must be stored away from children.

The irrigation valves may become permanently damaged if exposed to temperatures below 5 °C. We advise you to take the following measures before the onset of frost:

1. Close the tap and detach the connecting hose between the tap and the GARDENA Connecting Point, Art. 2722.
2. If the irrigation system is connected directly to your house's water system: Turn off the water supply and open the drain cock in the water pipe for the house.
3. Set the selection lever on all valves to the "ON" position.
4. Drain the irrigation valve/valve box.

This can be done in the following ways:

- Drain the system using compressed air

– or –



- remove all valves and store in a frost-free place

– or –

- for the Valve Box V3, open the drain cap and drain the supply pipe. As long as the pipes coming from the Valve Box V3 outlets are drained via a drain valve (e.g. in the GARDENA pop-up sprinklers) which is not attached at a higher point than the irrigation valve, the irrigation valves can be left mounted in the valve box.
- The smart Irrigation Control can remain installed after it has been deactivated.

7. TROUBLESHOOTING

7.1 Troubleshooting table:

Problem	Possible Cause	Remedy
 LED Power illuminates red	Undervoltage.	→ Check the power connection.
	Wrong power supply.	→ Check the power supply.
	MCU Communication error.	→ Reset the Irrigation Control to factory settings.
 LED Active Watering flashes red	Can't open valve because of limit of 2.	→ Check the program.
	Valve is not connected.	→ Check the valve.
	Single channel overcurrent.	→ Check the current of the channel.
	Sum overcurrent.	→ Check the sum current of the valves.
	Watering schedule cancelled.	→ Restart the program.
	Master channel error.	→ Check the master channel.
	Watering duration too short.	→ Increase the watering duration.
Watering program is not being undertaken (no watering)	The valve has previously been manually opened.	→ Avoid any program overlap.
	Water tap closed.	→ Open the water tap.
No function	Faulty wiring.	→ Check the cable terminals.
	Power supply unit is not connected.	→ Connect the power supply unit.
	Power supply unit is too hot.	→ Disconnect the power supply unit and let it be cooled down. Connect the power supply unit again.
		→ Protect the power supply unit from direct sunlight.

Problem	Possible Cause	Remedy
Inclusion is not possible (Inclusion)	No wireless connection to the gateway.	→ Select another position for the Irrigation Control or the gateway.
	No power supply available.	→ Check the mains cable.
Irrigation Control does not respond	Faulty wiring.	→ Check the cable terminals.
	No wireless connection to the gateway.	→ Check the wireless connection to the gateway.

NOTE:

Repairs must only be done by the GARDENA service departments or specialist dealers approved by GARDENA.

→ For any other malfunctions please contact the GARDENA service department.

8. TECHNICAL DATA

<i>smart Irrigation Control</i>	Unit	Value (Art. 19035)
Input voltage	V (DC)	36
Input current	mA	1000
Output voltage	V (AC)	24
Max. output current	mA	900
Operation temperature range (outdoors)	°C	+5 – +40
SRD:		
Frequency range	MHz	863 – 870
Maximum power	mW	25
Free field radio range (approx.)	m	100
Power supply		
Mains voltage	V (AC)	100 – 240
Mains frequency	Hz	50 – 60
Rated power	W	36
Standby power (approx.)	W	< 0.1
Output voltage	V (DC)	36
Max. output current	mA	1000

EC/UKCA Declaration of Conformity:

Hereby, GARDENA Manufacturing GmbH declares that the radio equipment type (Art. 19035) is in compliance with directive 2014/53/EU.

The full text of the EC/UKCA declaration of conformity is available at the following internet address: **www.gardena.com**

9. ACCESSORIES/SPARE PARTS

GARDENA smart Sensor	Sensor for controlling the smart system.	Art. 19040
GARDENA Watering Valve 24 V	Valve for controlling individual parts of an irrigation system.	Art. 1278
GARDENA Valve Boxes	Box for installing the watering valves underground.	Art. 1254/1255
GARDENA Connection Cable	Cable for connecting watering valves.	Art. 1280
GARDENA Cable Clips	Clip for the water-tight connection of connection cables.	Art. 1282

10. WARRANTY / SERVICE

10.1 Product registration

Please register your product at [gardena.com/registration](https://www.gardena.com/registration).

10.2 Service

Please find the current contact information of our service on the back page and online:

- United Kingdom: <https://www.gardena.com/uk/support/advice/contact/>
- USA: <https://us.gardena.com/pages/contact>
- Canada: <https://www.gardena.com/ca-en/c/support/contact>
- Australia: <https://www.gardena.com/au/support/advice/contact/>
- New Zealand: <https://www.gardena.com/nz/support/advice/contact/>
- South Africa: <https://www.gardena.com/za/support/contact/>
- Other countries: <https://www.gardena.com/int/c/support/contact>

11. DISPOSAL

11.1 Disposal of the Irrigation Control:

(according to Directive 2012/19/EU/S.I. 2013 No. 3113)



The product must not be disposed of to normal household waste. It must be disposed of in line with local environmental regulations.

IMPORTANT!

Dispose of the product through or via your local recycling collection centre.

12. TRADEMARK ATTRIBUTION

Apple and the Apple logo are trademarks of Apple Inc., registered in the U.S. and other countries. App Store is a service mark of Apple Inc. registered in the U.S. and other countries.

Google and the Google Play logo are trademarks of Google LLC.

Amazon, Alexa and all related logos are trademarks of Amazon.com, Inc. or its affiliates.

Other trademarks and trade names are those of their respective owners.

Deutschland / Germany
GARDENA Manufacturing GmbH
Central Service
Hans-Lorenser-Straße 40
D-89079 Ulm
Produktfragen:
(+49) 731 490-123
Reparaturen:
(+49) 731 490-290
www.gardena.com/de/kontakt

Albania
KRAFT SHPK
Autostrada Tirane-Durres
Km 7
1051 Tirane
Phone: (+355) 69 877 7821
info@kraft.al

Argentina
ROBERTO C. RUMBO S.R.L.
Predio Norlog
Lote 7
Benavidez ZC: 1621
Buenos Aires
Phone: (+54) 11 5263-7862
ventas@rumbosrl.com.ar

Armenia
AES Systems LLC
Marshal Babajanyan Avenue 56/2
0022 Yerevan
Phone: (+374) 60 651 651
masisohanyan@icloud.com

Australia
Husqvarna Australia Pty. Ltd.
Locked Bag 5
Central Coast BC
NSW 2252
Phone: (+61) (0) 2 4352 7400
customer.service@husqvarna.com.au

Austria / Österreich
Husqvarna Austria GmbH
Industriezeile 36
4010 Linz
Tel.: (+43) 732 77 01 01-485
www.gardena.com/at/service/beratung/
kontakt/

Azerbaijan
Progress Xüsusi Firması
Aliyar Aliyev 212. Baku, Azerbaijan
Sales: +994 70 326 07 14
Aftersales: +994 77 326 07 14
www.progress-garden.az
info@progress-garden.az

Bahrain
M.H. Al-Mahroos
BUILDING 208, BLOCK 356,
ROAD 328
Sahiya
Phone: +973 1740 8090
almahroos@almahroos.com

Belarus / Беларусь
OOO «Мастер Гарден»
220118, г. Минск
ул.Ица Шаранговича, дом 7а
Tel.: (+375) 17 257 00 33
mg@mastergarden.by

Belgium
Husqvarna Belgium nv
Gardena Division
Leuvensesteenweg 542
Planet II E
1930 Zaventem
België

Bosnia / Herzegovina
Silk Trade d.o.o.
Poslovna Zona Vila Br. 20
Phone: (+387) 61 165 593
info@silkttrade.com.ba

Brazil
Nordtech Maquinas e Motores Ltda.
Avenida Juscelino Kubitschek
de Oliveira Curitiba
3003 Brazil
Phone: (+55) 41 3595-9600
contato@nordtech.com.br
www.nordtech.com.br

Bulgaria
AGROLAND България АД
бул. 8 Декември, № 13
Офис 5
1700 Студентски град
София
Tel.: (+359) 24 66 6910
info@agroland.eu

Canada / USA
GARDENA Canada Ltd.
125 Edgeware Road
Unit 15 A
Brampton L6Y 0P5
ON, Canada
Phone: (+1) 905 792 93 30
gardena.customerservice@
husqvarnagroup.com

Chile
REPRESENTACIONES JCE S.A.
AV. DEL VALLE NORTE 857 PISO 4
HUECHURABA, SANTIAGO, CHILE
Phone: (+56) 2 2414 2600
contacto@jce.cl

China
Husqvarna (Shanghai)
Management Co., Ltd.
富世华 (上海) 管理有限公司
3F, Benq Square B,
No 207, Song Hong Rd.,
Chang Ning District,
Shanghai, P.R.C. 200035
上海市长宁区淞虹路207号明
基广场B座3楼, 邮编: 200335

Colombia
Equipos de Toiyama Colombia SAS
Cra. 68 D No 25 B 86 Of. 618
Edificio Torre Central
Bogotá
Phone: +57 (1) 703 95 20 /
+57 (1) 703 95 22
servicioalcliente@toiyama.com.co
www.toiyama.com.co

Costa Rica
Exim CIA Costa Rica
Calle 25A, B°. Montelegre
Zapote
San José
Costa Rica
Phone: (+506) 2221-5654
(+506) 2221-5659
eximcostarica@gmail.com

Croatia
Husqvarna Austria GmbH
Industriezeile 36
4010 Linz
Phone: (+43) 732 77 01 01-485
service.gardena@husqvarnagroup.com

Cyprus
Pantelis Papadopoulos S.A.
92 Athinon Avenue
Athens
10442 Greece
Phone: (+30) 21 0519 3100
info@papadopoulos.com.gr

Czech Republic
Gardena
Service Center Vrbo
c/o Husqvarna
Manufacturing CZ s.r.o.
Jesenická 146
79326 Vrbo pod Pradedem
Phone: 800 100 425
servis@gardena.cz

Denmark
GARDENA DANMARK
Lejrvvej 19, st.
3500 Værlose
Tel.: (+45) 70 26 47 70
gardenack@husqvarnagroup.com
www.gardena.com/dk

Dominican Republic
BOSQUESA, S.R.L.
Carretera Santiago Licey
Km. 5 ½
Esquina Copal II.
Santiago De Los Caballeros
51000 Dominican Republic
Phone: (+1) 809-562-0476
info@bosquesa.com.do

Egypt
Universal Agencies Co
26, Abdel Hamid Lotfy St.
Giza
Phone: (+20) 3 761 57 57

Estonia
Husqvarna Eesti OÜ
Valdeku 132
EE-11216 Tallinn
info@gardena.ee

Finland
Oy Husqvarna Ab
Juurakkotie 5 B 2
01510 Vantaa
www.gardena.fi

France
Husqvarna France
9/11 Allée des pierres mayettes
92635 Gennevilliers Cedex
France
http://www.gardena.com/fr
N° AZUR: 0 810 00 78 23
(Prix d'un appel local)

Georgia
Transporter LLC
#70, Beliasvili street
0159 Tbilisi, Georgia
Number: (+995) 322 14 71 71
info@transporter.com.ge
www.transporter.com.ge

**Service Address and
Importer to Great Britain**
Husqvarna UK Ltd
Preston Road
Aycliffe Industrial Park
Newton Aycliffe
County Durham
DL5 6UP
Phone: (+44) (0) 344 844 4558
info.gardena@husqvarna.com.uk

Greece
Π.ΠΑΠΑΔΟΠΟΥΛΟΣ ΕΒΕΕ
Λαοικ. Αθηνών 92
Αθήνα
T.K.104 42
ΕΛΛΑδα
Τηλ.Α (+30) 210 5193 100
info@papadopoulos.com.gr

Hong Kong
Tung Tai Company
151-153 Hoi Bun Road
Kwun Tong, Kowloon
Hong Kong
Phone: (+852) 3583 1662
admin@tungtaico.com

Hungary
Husqvarna Magyarország Kft.
Ezred u. 1 – 3
1044 Budapest
Phone: (+36) 1 251-4161
vevoszolgalat.husqvarna@husqvarna.hu

Iceland
BYKO ehf.
Stemmuvegji 2a
200 Kópavogur
Phone: (+354) 515 4000
byko@byko.is

Italy
MHG Verstun ehf
Vikurhvarf 8
203 Kópavogur
Phone: (+354) 544 4656

India
B K RAMAN AND CO
Plot No. 185, Industrial Area,
Phase-2, Ram Darbar
Chandigarh
160002 India
Phone: (+91) 98140 06530
raman@jaganhardware.com

Iraq
AlShiem Alakhdar Company
Al-Faysaleah, Near Estate Bank
Mosul
Phone: (+964) 78 18 18 46 75

Ireland
Liffey Distributors Ltd.
309 NW Business Park, Ballycoolen
15 Dublin
Phone: (+353) 1 824 2600
EE-11216 Tallinn
info@liffeyd.com

Israel
HAGARIN LTD.
2 Nahal Harif St.
8122201 Yavne
internet@hagarin.co.il
Phone: (+972) 8-932-0400

Italy
Husqvarna Italia S.p.A.
Centro Direzionale Planum
Via del Lavoro 2, Scala B
22036 ERBA (CO)
Phone: (+39) (0) 31 4147700
assistenza.italia@it.husqvarna.com

Japan
Husqvarna Zenoah Co. Ltd. Japan
1-9 Minamidai, Kawagoe
350-1165 Saitama
Japan
gardena-jp@husqvarnagroup.com

Kazakhstan
ТОО "Ламэд"
Russian
Адрес: Казахстан, г. Алматы,
ул. Тажимаевой, 155/1
Тел.: (+7) (727) 355 64 00
(+7) (700) 355 64 00
lamed@lamed.kz

Kuwait
Palms Agro Production Co
Al Rai- Fourth Ring Road – Block 56.
P.O.Box: 1976 Safat
13020 Al-Rai
Phone: (+965) 24 73 07 45
info@palms-kw.com

Kyrgyzstan
OOs Alye Maki
Av. Moladaya Guardia 83
720014 Bishkek
Phone: (+996) 312 322115

Latvia
Husqvarna Latvija SIA
Ulbroskas 19A
LV-1021 Riga
info@gardena.lv

Lebanon
Technomec
Safra Highway (Beirut – Tripoli) Center
622 Mezher Bldg.
P.O.Box 215
Jounieh
Phone: (+961) 9 853527 /
(+961) 3 855481
tecnomec@idm.net.lb

Lithuania
UAB Husqvarna Lietuva
Ateities pl. 77C
LT-52104 Kaunas
info@gardena.lt

Luxembourg
Magasins Jules Neuberger
39, rue Jacques Stas
Luxembourg-Gasperich 2549
Case Postale No. 12
Luxembourg 2010
Phone: (+352) 40 14 01
api@neuberger.lu

Malaysia
Glomedic International Sdn Bhd
Jalan Ruang No. 30
Shah Alam, Selangor
40150 Malaysia
Phone: (+60) 3-7734 7997
oase@glomedic.com.my

Malta
I.V. Portelli & Sons Ltd.
85, 86, Triq San Pawl
Rabat - RBT 1240
Phone: (+356) 2145 4289

Mauritius
Espace Maison Ltée
AV. CHIFFERES DEL CHACO
1449 C/25 DE MAYO
Quatre Bornes
Phone: (+230) 460 85 85
digital@espacemaison.mu

Mexico
AFUSA
Av. Lopez Mateos Sur # 5019
Col. La Calma 45070
Zapopan, Jalisco, Mexico
Phone: (+52) 33 3818-3434
isolis@afosa.com.mx

Moldova
Convel SRL
Republica Moldova,
mun. Chisinau,
sos. Muncesti 284
Phone: (+373) 22 857 126
www.convel.md

Mongolia
Soyol Gardening Shop
Narnii Rd
Ulaanbaatar
14230 Mongolia
Phone: +976 7777 5080
soyolj@magicnet.mn

Morocco
Proekip
64 Rue de la Participation
Casablanca-Roches Noires
20303 Morocco
Phone: (+212) 661342107
hicham.hafani@proekip.ma

Netherlands
Husqvarna Nederland B.V.
GARDENA Division
Postbus 50131
1305 AC ALMERE
Phone: (+31) 36 521 00 10
info@gardena.nl

Neth. Antilles
Jonka Enterprises N.V.
Sta. Rosa Weg 196
P.O. Box 8200
Curaçao
Phone: (+599) 9 767 66 55
info@jonka.com

New Zealand
Husqvarna New Zealand Ltd.
P.O. Box 76-437
Manukau City 2241
Phone: (+64) (0) 9 9202410
support.nz@husqvarna.com.nz

North Macedonia
Sinpeks d.o.o.
Ul. Kravarski Pat Bb
7000 Bitola
Phone: (+886) 47 20 85 00
sinpeks@mt.net.mk

Norway
Husqvarna Norge AS
Gardena Division
Trøskerveien 36
1708 Sarpsborg
info@gardena.no

Northern Cyprus
Mediterranean Home & Garden
No 150 Alsancak, Karaoglanözü
Caddesi Girne
Phone: (+90) 392 821 33 80
info@medgardener.com

Oman
General Development Services
PO 1475, PC - 111
Seeb
111 Oman
Phone: 96824582816
gdsoman@gdsoman.com

Paraguay
Agrofield SRL
AV. CHIFFERES DEL CHACO
1449 C/25 DE MAYO
Asunción
Phone: (+595) 21 608 656
consultas@agrofield.com.py

Peru
Sierras y Herramientas Forestal SAC
Av. Las Gaviotas 833, Chorrillos
Lima
Phone: (+51) 1 2 52 02 52
supervisorventas1@siersac.com
www.siersac.com

Philippines
Royal Dragon Traders Inc
10 Linaw Street, Barangay
Saint Peter Quezon City
1114 Philippines
Phone: (+63) 2 7426893
aida.fernandez@rdti.com.ph

Poland
Gardena Service Center Vrbo
c/o Husqvarna Manufacturing CZ
s.r.o. Jesenícká 146
79326 Vrbo pod Pradedem
Czech Republic
Phone: (22) 336 78 90
servis@gardena.cz

Portugal
Husqvarna Portugal, SA
Lagoa - Albarraque
2635 - 595 Rio de Mouro
Phone: (+351) 21 922 85 30
Fax: (+351) 21 922 85 36
info@gardena.pt

Romania
Madex International Srl
Soseaua Odaii 117 - 123,
RO 013603 Bucuresti, S1
Phone: (+40) 21 352 7603
madex@ines.ro

Russia / Россия
OOO „Хукварна“
141400, Московская обл.,
г. Химки,
улица Ленинградская,
владение 39, стр.6
Бизнес Центр
„Химки Бизнес Парк“,
помещение 0B02_04
http://www.gardena.ru

Saudi Arabia
SACO
Takhassusi Main Road P.O. Box:
06387 Riyadh 12863
40011 Saudi Arabia
Phone: (966) 11 482 8877
webmaster@saco-ksa.com

Al Futtaim Pioneer Trading
5147 Al Farooq Dist.
Riyadh 7991
Phone: (+971) 4 206 6700
Owais.Khan@alfuttaim.com

Serbia
Domel d.o.o.
Slobodana Burića 21
11000 Belgrade
Phone: (+381) 11 409 57 12
office@domel.rs

Singapore
Hy-Ray PRIVATE LIMITED
40 Jalan Pemimpin
#02-08 Tat Ann Building
Singapore 577185
Phone: (+65) 6253 2277
info@hyray.com.sg

Slovak Republic
Gardena
Service Center Vrbo
c/o Husqvarna
Manufacturing CZ s.r.o.
Jesenická 146
79326 Vrbo pod Pradedem
Phone: 0800 154044
servis@gardena.sk

Slovenia
Husqvarna Austria GmbH
Industriezeile 36
4010 Linz
Phone: (+43) 732 77 01 01-485
service.gardena@husqvarnagroup.com

South Africa
Husqvarna South Africa (Pty) Ltd
Lifestyle Business Park
Ground Floor Block A Cnr
Beyers Naude Drive and Ysterhout
Road Randpark Ridge, Randburg
Phone: (+27) 10 015 5750
service@gardena.co.za

South Korea
Kyung Jin Trading Co., Ltd
8F Haengbok Building, 210,
Gangnam-Daero 137-891 Seoul
Phone: (+82) 2 574 6300
kjh@kjh.co.kr

Spain
Husqvarna España S.A.
Calle de Rivas nº 10
28052 Madrid
Phone: (+34) 91 708 05 00
atencioncliente@gardena.es

Sri Lanka
Hunter & Company Ltd.
130 Front Street
Colombo
Phone: 94-11 232 81 71
hunters@eureka.lk

Suriname
Deto Handelmaatschappij N.V.
Kerkkampweg 72-74
P.O. Box: 12782
Paramaribo
Suriname
Phone: (+597) 43 80 50
info@deto.sr

Sweden
Husqvarna AB /
GARDENA Sverige
Drottninggatan 2
561 82 Huskvarna
Sverige
Phone: (+46) (0) 36-14 60 02
service@gardena.se

Switzerland / Schweiz
Husqvarna Schweiz AG
Consumer Products
Industriestrasse 10
5506 Mägenwil
Phone: (+41) (0) 62 887 37 90
info@gardena.ch

Taiwan
Hong Ying Trading Co., Ltd.
No. 46 Wu-Kun-Wu Road
New Taipei City
Phone: (+971) 02298 1486
salesg1@friendsz.com.tw

Tajikistan
ARIFERS JV LLC
39, Ayri Street, 734024
Dushanbe, Tajikistan

Thailand
Spica Co. Ltd
243/2 Onnuh Rd., Prawat
Bangkok
10250 Thailand
Phone: (+66) (0)2721 7373
surapong@spica-siam.com

Tunisia
Sociétés du matériel agricole et maritime
Nouveau port de peche de Slax Bp 33
Slax 3065
Phone: (+216) 98 419047/
(+216) 74 497614
commercial@smanmtunisia.com

Türkiye
Dost Bahçe
Yunus Mah. Adil Sk. No:3
Kartal
Istanbul
34873 Türkiye
Phone: (+90) 216 389 39 39

Türkmenistan
I.E. Orazmuhammedov Nurmuhammet
80 Ataturk, BERKARAR Shopping Center,
Ground floor, A77b,
Ashgabat 744000
TURKMENISTAN
Phone: (+993) 12 468859
Mob: (+993) 62 222887
info@jayhyzmat.com /
bekgiyev@jayhyzmat.com
www.jayhyzmat.com

UAE
Al-Futtaim ACE Company
L.L.C Building, Al Rebat Street
Festival City, Dubai
7880 UAE
Phone: (+971) 4 206 6700
ace@alfuttaim.ae

Ukraine / Україна
AT «Анцест»
вул.Петропавлівська 4
08130, Київська обл.
Київ-Соломийський р-н. с.
Петропавлівська Борщагівка Україна
Тел.: (+38) 0 800 503 000

Uruguay
FELI SA
Entre Rios 1083
11800 Montevideo
Phone: (+598) 22 03 18 44
info@felisa.com.uy

Uzbekistan
AGROHOUSE MChJ
O'zbekiston, 111112
Toshkent tumani
Toshkent tumani
Hasanboy OFY, THAY voqasida
Phone: (+998) 93-5414141 /
(+998) 71-2096868
info@agro.house
www.agro.house

Vietnam
Vision Joint Stock Company
BT1-17, Khu biet thu –
Khu Doan ngoai giao Nguyen Xuan Khoat
Hanoi, Vietnam
Phone: (+8424)-38462833/34
quynhnm@visionjsc.com.vn

Zimbabwe
Cutting Edge
159 Citroen Rd, Msasa
Harare
Phone: (+263) 8677 008685
sales@cuttingedge.co.zw

19035-20.962.02/0324
© GARDENA Manufacturing GmbH
D-89079 Ulm
https://www.gardena.com