

**BLi-18 / 2,6 Ah**  
**Art. 9839**

<b>D Betriebsanleitung</b> Wechselaccu	<b>SK Návod na obsluhu</b> Náhradný akumulátor
<b>GB Operating Instructions</b> Replacement Battery	<b>GR Οδηγίες χρήσης</b> Ανταλλακτική μπαταρία
<b>F Mode d'emploi</b> Batterie remplaçable	<b>RUS Инструкция по эксплуатации</b> Батарея сменная
<b>NL Gebruiksaanwijzing</b> Wisselaccu	<b>SLO Navodilo za uporabo</b> Nadomestni akumulator
<b>S Bruksanvisning</b> Utbytes Batteri	<b>HR Uputa za upotrebu</b> Zamjenska accu baterija
<b>DK Brugsanvisning</b> Batteri	<b>SRB/ Upustvo za korisnike</b> BIH Rezervna punjiva baterija
<b>FI Käyttöohje</b> Vara-akku	<b>UA Інструкція з експлуатації</b> Змінний акумулятор
<b>N Bruksanvisning</b> Utbyttbart Batteri	<b>RO Instrucțiuni de utilizare</b> Baterie rezervă
<b>I Istruzioni per l'uso</b> Batteria di ricambio	<b>TR Kullanma Kılavuzu</b> Değiştirilebilir Batarya
<b>E Instrucciones de empleo</b> Batería de sustitución	<b>BG Инструкция за експлоатация</b> Сменяеми батерии
<b>P Manual de instruções</b> Acumulador de substituição	<b>AL Manual përdorimi</b> Akumulator këmbyses
<b>PL Instrukcja obsługi</b> Akumulator	<b>EST Kasutusjuhend</b> Vahetusaku
<b>H Használati utasítás</b> Csereakkumulátor	<b>LT Naudojimosi instrukcija</b> Keičiamas akumuliatorius
<b>CZ Návod k obsluze</b> Náhradní akumulátor	<b>LV Lietošanas instrukcija</b> Maināmais akumulators

**BLi-18 / 2,6 Ah (Art. 9839)**

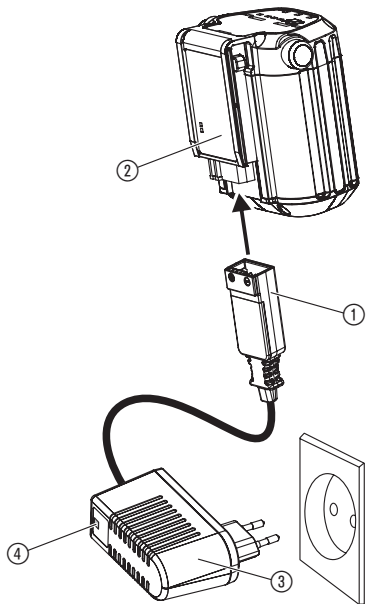
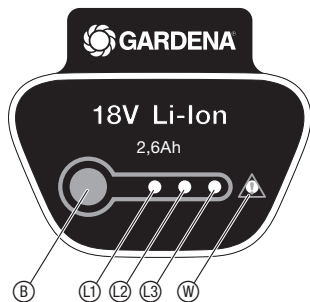

**GARDENA Replacement Battery****BLI-18 Battery**

Translation of the original German operating instructions. Please read these operating instructions carefully and observe the notes given. Acquaint yourself with the use of the battery, the charging technology (see operating instructions GARDENA Rechargeable Battery unit) and observe the safety instructions.

For safety reasons, children under the age of 16 as well as people, who are not acquainted with the instructions should not use the battery. Persons with reduced physical or mental abilities may use the product only if they are supervised or instructed by a responsible person. Children must be supervised to ensure that they do not play with the product. Never operate the product when you are tired, ill or under the influence of alcohol, drugs or medicine.

→ Please keep these operating instructions in a safe place.

**1. Area of application of your GARDENA Replacement Battery**

*Proper use as directed:*

The rechargeable battery is used as a power supply for the relevant GARDENA cordless appliances and is intended for use in private house and hobby gardens. The replacement battery must not be used in public facilities, parks, sports grounds, next to roads or in agriculture or forestry. Observance of the operating instructions provided by GARDENA is a prerequisite for correct use of the rechargeable battery.

**2. Safety Instructions**

→ Please observe the safety instructions on the battery.



**FIRE RISK! Short-circuit!**

→ **Do not bridge the contacts of the battery with metal components.**

*Check your replacement battery before each use:*

Visually check the battery before each use. A non-functioning battery must be disposed of correctly. It may not be sent via post. For further details, please contact your local disposal companies.

*Use/responsibility:*

Attention! For risks of injury the battery must not be used as power source for other devices. Only use the battery for the GARDENA appliances intended.

Electrical safety:



#### FIRE RISK!

→ The battery to be charged must be placed on a non-flammable, heat resistant and non-conductive surface while charging. Keep corrosive, flammable and easily combustible objects clear of the battery charger and the battery. Do not cover the battery charger and the battery while charging. Unplug the battery charger immediately in the event of smoke formation or fire.

Only original GARDENA Charger Units may be used for charging. The use of other battery chargers may damage the batteries irreparably and even cause a fire.



#### RISK OF EXPLOSION!

Protect batteries from heat and fire. Do not leave on radiators or expose to strong sunshine for long periods.

Only use and charge the battery in ambient temperatures of between 0 °C and 40 °C. Allow battery to cool down after long periods of use. The charging cable should be checked regularly for signs of damage or ageing (brittleness) and may only be used if it is in perfect condition.

Storage:

Do not store the battery above 45 °C or in direct sunlight. Ideally, the battery should be stored below 25 °C so that self-discharge is low. Never store while still attached to a tool, this prevents misuse and accidents.

Do not store the battery in places where static electricity is present.

Warning! This machine produces an electromagnetic field during operation. This field may under some circumstances interfere with active or passive medical implants. To reduce the risk of serious or fatal injury, we recommend persons with medical implants to consult their physician and the medical implant manufacturer before operating this machine. Do not use the product when a thunderstorm is approaching.

Danger! Small parts could be swallowed during assembly and there is a risk of suffocation from the polybag. Keep infants away during assembly.

### 3. Initial Operation

Charging the battery (see page 2):



#### ATTENTION!

Overvoltage damages batteries and the battery charger.

→ Ensure the correct mains voltage.

Before using for the first time, the battery must be fully charged.

The lithium-ion battery can be charged in any state of charge and the charging process can be interrupted at any time without harming the battery (no memory effect).

1. Plug the plug of the charger cable ① into the battery ②.
2. Plug standard charger ③ into a mains power socket.

**Charging control lamp ④ at the charger unit flashes green once per second: Battery is being charged.**

**Charging control lamp ④ at the charger unit is lit green: Battery is fully charged.** (For charging time, see 7. Technical Data).

Check the charge status regularly while charging.

**Battery charging status indicator during charging:**

100 % charged	L1, L2 and L3 lit.
66 – 99 % charged	L1 and L2 lit, L3 flashing.
33 – 65 % charged	L1 lit, L2 flashing.
0 – 32 % charged	L1 flashing.

3. Once completely charged, disconnect the battery ② from the battery charger ③. Disconnect the battery ② from the battery charger ③ first, then unplug the battery charger ③.

**Battery charging status indicator during operation:**

→ Press button ⑤ on the battery.

66 – 99 % charged	L1, L2 and L3 lit.
33 – 65 % charged	L1 and L2 lit.
10 – 32 % charged	L1 lit.
1 – 9 % charged	L1 flashing.
0 % charged	No indicator.

#### 4. Storage

*Storage / overwintering:*

The battery must be stored out of the reach of children.

1. Charging the battery.
2. Store the battery in a dry place.



Li-ion *Disposal of batteries:*

The GARDENA battery contains lithium-ion cells that should not be discarded with normal household waste at the end of their life.

Important:

Please return the lithium-ion batteries to your GARDENA dealer or dispose of them properly at a public recycling centre.







1. Discharge lithium-ion cells completely.
2. Dispose of lithium-ion cells properly.

#### 5. Maintenance

Make sure the surface and the contacts of the battery always are clean and dry before connecting the charging unit. When dirty clean them with a soft, dry rag; never use running water.

#### 6. Troubleshooting

Error messages of the error-LED  (see page 2).

Problem	Possible Cause	Remedy
Device stops. Error-LED  flashing.	Battery Overload.  High temperature. The allowed operation temperature was exceeded.	Wait 10 sec. Press button  on the battery and restart device.  Leave battery to cool for approx. 15 min. Press button  on the battery and restart device.
Charging control lamp  on the charger does not light up.	Battery charger or charging cable not plugged in properly.	Plug in battery charger and charging cable properly.
Charging control lamp  on the charger flashing rapidly (twice per second).	Charging error.	Unplug charger and plug in again.
Device stops. Error-LED  lit.	Battery error / battery defective.	Press button  on the battery and restart device.

For any other malfunctions please contact the GARDENA service department. Repairs must only be carried out by GARDENA service departments or specialist dealers authorised by GARDENA.

#### 7. Technical Data

**Art. 9839**

Battery voltage	Li-Ion 18 V
Battery capacity	2.6 Ah
Battery charging time	approx. 3.5 hrs 80 % / approx. 5 hrs 100 %

#### 8. Service / Warranty

Service: Please contact the address on the back page.

Guarantee: GARDENA Manufacturing GmbH guarantees this unit for 2 years (from date of purchase). This guarantee covers all serious defects of the unit that can be proved to be material or manufacturing faults. Under warranty we will either replace the unit or repair it free of charge if the following conditions apply:

- The unit must have been handled properly and in keeping with the requirements of the operating instructions.
- Neither the purchaser or a non-authorized third party have attempted to repair the unit.

This manufacturer's guarantee does not affect the user's existing warranty claims against the dealer / seller.

If you have problems with this unit, please contact our Service.

**GB Product Liability**

We expressly point out that, in accordance with the product liability law, we are not liable for any damage caused by our units if it is due to improper repair or if parts exchanged are not original GARDENA parts or parts approved by us, and, if the repairs were not carried out by a GARDENA Service Centre or an authorised specialist. The same applies to spare parts and accessories.

**F Responsabilité**

Nous vous signalons expressément que GARDENA n'est pas responsable des dommages causés par ses appareils, dans la mesure où ces dommages seraient causés suite à une réparation non conforme, dans la mesure où, lors d'un échange de pièces, les pièces d'origine GARDENA n'auraient pas été utilisées, ou si la réparation n'a pas été effectuée par le Service Après-Vente GARDENA ou l'un des Centres SAV agréés GARDENA. Ceci est également valable pour tout ajout de pièces et d'accessoires autres que ceux préconisés par GARDENA.

**NL Productaansprakelijkheid**

Wij wijzen er nadrukkelijk op, dat wij op grond van de wet aansprakelijkheid voor producten niet aansprakelijk zijn voor schade ontstaan door onze apparaten, indien deze door onvakkundige reparatie veroorzaakt zijn, of er bij het uitwisselen van onderdelen geen gebruik gemaakt werd van onze originele GARDENA onderdelen of door ons vrijgegeven onderdelen en de reparatie niet door de GARDENA technische dienst of de bevoegde vakman uitgevoerd werd. Ditzelfde geldt voor extra-onderdelen en accessoires.

**S Produktansvar**

Tillverkaren är inte ansvarig för skada som orsakats av produkten om skadan beror på att produkten har reparerats felaktigt eller om, vid reparation eller utbytte, andra än Original GARDENA reservdelar har använts. Samma sak gäller för kompletteringsdelar och tillbehör.

**DK Produktansvar**

Vi gør udtrykkeligt opmærksom på, at vi i henhold til produktansvarsloven ikke er ansvarlige for skader forårsaget af vores udstyr, såfremt det sker på grund af uautoriserede reparationer eller hvis dele er skiftet ud og der ikke er anvendt originale GARDENA dele eller dele godkendt af os, eller hvis reparationerne ikke er udført af GARDENA-service eller en autoriseret fagmand. Det samme gælder for ekstra udstyr og tilbehør.

**FI Tuotevastuu**

Korostamme nimenomaan, että tuotevastuulain nojalla emme ole vastuussa laitteistamme johtuneista vahingoista, mikäli nämä ovat aiheutuneet epäasianmukaisesta korjauksesta tai osia vaihdettaessa ei ole käytetty alkuperäisiä GARDENA-varaosia tai hyväksymiamme osia ja korjauksen on suorittanut muu kuin GARDENA-huoltokeskus tai valtuuttamamme ammattihenkilö. Tämä pätee myös lisäosiin ja lisävarusteisiin.

**I Responsabilità del prodotto**

Si rende espressamente noto che, conformemente alla legislazione sulla responsabilità del prodotto, non si risponde di danni causati da nostri articoli se originati da riparazioni eseguite non correttamente o da sostituzioni di parti effettuate con materiale non originale GARDENA o comunque da noi non approvato e, in ogni caso, qualora l'intervento non venga eseguito da un centro assistenza GARDENA o da personale specializzato autorizzato. Lo stesso vale per le parti complementari e gli accessori.

**E Responsabilidad de productos**

Advertimos que conforme a la ley de responsabilidad de productos no nos responsabilizamos de daños causados por nuestros aparatos, siempre y cuando dichos daños hayan sido originados por arreglos o reparaciones indebidas, por recambios con piezas que no sean piezas originales GARDENA o bien piezas no autorizadas por nosotros, así como en aquellos casos en que la reparación no haya sido efectuada por un Servicio Técnico GARDENA o por un técnico autorizado. Lo mismo es aplicable para las piezas complementarias y accesorios.

**P Responsabilidade sobre o produto**

Queremos salientar que segundo a lei da responsabilidade do fabricante, nós não nos responsabilizaremos por danos causados pelo nosso equipamento, quando estes ocorrerem em decorrência de reparações inadequadas ou da substituição de peças por peças não originais da GARDENA, ou peças não autorizadas. A responsabilidade tornar-se-à nula também depois de reparações realizadas por oficinas não autorizadas pela GARDENA. Esta restrição valerá também para peças adicionais e acessórios.

**PL Odpowiedzialność za produkt**

Zwracamy Państwa uwagę, że nie ponosimy odpowiedzialności za uszkodzenia naszych maszyn, bądź szkody spowodowane ich wadliwym funkcjonowaniem, powstałe na skutek nieprawidłowo przeprowadzonych napraw lub użycia nieoryginalnych części zamiennych. Naprawy winny być przeprowadzane tylko przez punkty serwisowe Husqvarna lub autoryzowane serwisy. Dotyczy to również części uzupełniających i przyrządowania.

**H Természavatosság**

Nyomatékosan utalunk arra a tényre, hogy a természavatossági törvény szerint nem kell jótállást vállalnunk azokra a károokra, amelyeket nem a mi készülőkeink okoztak, ha ezeket szakszerűtlen javítás okozta vagy egy alkatrész kicserélésénél nem a mi eredeti GARDENA alkatrészekenket vagy általunk engedélyezett alkatrészeket használtak fel és a javítást nem a GARDENA szerviz vagy egy erre felhatalmazott szakember végezte. Hasonlóképpen érvényes ez a kiegészítő alkatrészekre és tartozékokra is.

**CZ Odpovědnost za výrobek**

Výslovně upozorňujeme na to, že podle zákona o odpovědnosti za výrobek nenese me odpovědnost za škody způsobené našimi přístroji, pokud byly způsobené neodbornou opravou nebo použitím jiných než našich originálních náhradních dílů GARDENA nebo naší schválených dílů a neprovedením opravy servisem GARDENA nebo autorizovaným odborníkem. Odpovídající platí i pro doplňkové díly a příslušenství.

**SK Predmet záruky**

Upozorňujeme dôrazne na to, že podľa zákona o poskytovaní záruk nezodpovedáme za škody spôsobené našimi výrobkami, v prípade, že boli boli vyvolané neodbornými opravami, výmenou dielcov, ktoré nepatria k originálnym dielom GARDENA alebo neboli nami schválené avšak boli spôsobené servisnými zásahmi, ktoré neboli vykonané servisom GARDENA alebo autorizovaným odborníkom.  
Rovnako to platí pre doplnky a príslušenstvo.

**GR Ευθύνη για τα προϊόν**

Σας υπενθυμίζουμε ρητά, ότι σύμφωνα με το νόμο περί ευθύνης για τα προϊόντα δεν ευθυνόμαστε για ενδεχόμενες βλάβες που προκαλούνται από τις συσκευές μας, εφόσον οφείλονται σε μια ακατάλληλη επισκευή ή σε μια αντικατάσταση τμημάτων για την οποία δεν έχουν χρησιμοποιηθεί τα πρωτότυπα ανταλλακτικά της GARDENA ή τα από μας εγκεκριμένα ανταλλακτικά και σε περίπτωση που δεν εκτελείται η επισκευή από το Τμήμα Εξυπηρέτησης Πελατών της GARDENA ή από έναν εξουσιοδοτημένο εξειδικευμένο τεχνίτη.  
Το ίδιο ισχύει για εξαρτήματα και συμπληρωματικά τμήματα.

**SLO Jamstvo za izdelek**

Pismeno poudarjamo, da po zakonu jamstva za izdelek nismo odgovorni za škodo, ki bi nastala zaradi uporabe našega izdelka, prav tako tudi ne za škodo ki bi nastala zaradi nepravilnega popravila izdelka ali pri napačni zamenjavi delov, ki niso originalni deli GARDENA ali pri uporabi z naše strani potrjenih delov, ki pa niso bili vgrajeni v servisu GARDENA ali v naši pooblaščenih servisni službi.  
Enako velja tudi za nadomestne dele in opremo.

**HR Odgovornost za proizvod**

Izričito napominjemo da u skladu sa Zakonom o odgovornosti za proizvode nismo odgovorni za štete uzrokovane našim uređajima ako su one izazvane nestručnim popravkom ili u slućaju zamjene dijelova nisu korišćeni originalni GARDENA dijelovi ili dijelovi koje smo odobrili i popravak nije izvršio GARDENA servis ili ovlašteni stručnjak. Isto vrijedi i za dodatne dijelove i pribor.

**RO Responsabilitatea legala a produsului**

Menționam în mod expres ca, în concordanță cu responsabilitatea legală a produsului, nu suntem răspunzători de nici un accident provocat de produsele noastre dacă se datorează reparării necorespunzătoare sau dacă piesele de schimb nu sunt originale GARDENA sau aprobate de GARDENA, sau dacă reparațiile nu au fost efectuate de un Centru de Service GARDENA sau un specialist autorizat.  
Aceleași prevederi se aplică și pieselor de schimb și accesoriilor.

**BG Отговорност за качество**

Изрично подчертаваме, че съгласно закона за отговорност за качество, ние не носим отговорност за вредите причинени от нашите уреди, ако същите са причинени от неправилен ремонт или при подмяната на части не са използвани оригинални части на GARDENA или части одобрени от нас и ремонта не е извършен от сервиз на GARDENA или оторизиран специалист.  
Същото важи за допълнителните части и принадлежности.

**EST Tootevastutus**

Juhime teie tähelepanu sellele, et tootevastustusseaduse kohaselt ei vastuta me meie seadmete poolt põhjustatud kahjude eest, kui need on tekkinud asjatultumatu paranduse tagajärjel või kui detaili vahetamisel ei kasutatud GARDENA originaalvaruosi ega meie poolt kasutada lubatud varuosi ja kui parandustööd ei ole teinud GARDENA klienditeenindusspetsialistid ega meie volitatud spetsialistid.  
Sama kehtib lisadetailide ja tarvikute kohta.

**LT Atsakomybė už produkciją**

Nurodome, kad remdamiesi Atsakomybės už produkciją įstatymu, neatsakome už nuostolių, sukeltus mūsų prietaisų, jei jie atsirado dėl netinkamo remonto, arba, jei keičiant dalis, buvo naudojamasi neoriginalios GARDENA dalys arba dalys, kurių mes neleidome naudoti, o remontą atliko ne GARDENA servisas arba neįgaliotasis specialistas.  
Tas pats galioja papildomoms dalims ir priedams.

**LV Produkta atbildība**

Mēs skaidri norādām uz to, ka saskaņā ar Produktu atbildības likumu, mēs neatbildam par mūsu iekārtu radītiem zaudējumiem, ciktāl tos ir izraisījis neatbilstošs remonts vai daļu nomaņa ar neoriģinālām GARDENA daļām vai ne ar mūsu norādītājām detaļām un remontu nav veicis GARDENA serviss vai pilnvarots speciālists.  
Tas pats attiecas uz papildinošajām daļām un piederumiem.

**D EG-Konformitätserklärung**

Der Unterzeichnete Husqvarna AB, 561 82 Huskvarna, Sweden bestätigt, dass die nachfolgend bezeichneten Geräte in der von uns in Verkehr gebrachten Ausführung die Anforderungen der harmonisierten EU-Richtlinien, EU-Sicherheitsstandards und produktspezifischen Standards erfüllen. Bei einer nicht mit uns abgestimmten Änderung der Geräte verliert diese Erklärung ihre Gültigkeit.

**EB EU Declaration of Conformity**

The undersigned Husqvarna AB, 561 82 Huskvarna, Sweden hereby certifies that, when leaving our factory, the units indicated below are in accordance with the harmonised EU guidelines, EU standards of safety and product specific standards. This certificate becomes void if the units are modified without our approval.

**F Certificat de conformité aux directives européennes**

Le constructeur, soussigné : Husqvarna AB, 561 82 Huskvarna, Sweden déclare qu'à la sortie de ses usines le matériel neuf désigné ci-dessous était conforme aux prescriptions des directives européennes énoncées ci-après et conforme aux règles de sécurité et autres règles qui lui sont applicables dans le cadre de l'Union européenne. Toute modification portée sur ce produit sans l'accord express de GARDENA supprime la validité de ce certificat.

**NL EU-overeenstemmingsverklaring**

Ondergetekende Husqvarna AB, 561 82 Huskvarna, Sweden bevestigt, dat de volgende genoemde apparaten in de door ons in de handel gebrachte uitvoering voldoen aan de eis van, en in overeenstemming zijn met de EU-richtlijnen, de EU-veiligheidsstandaard en de voor het product specifieke standaard. Bij een niet met ons afgestemde verandering aan de apparaten verliest deze verklaring haar geldigheid.

**S EU Tillverkarintyg**

Undertecknad firma Husqvarna AB, 561 82 Huskvarna, Sweden intygar härmed att nedan nämnda produkter överensstämmer med EU:s direktiv, EU:s säkerhetsstandard och produktspecifikation. Detta intyg upphör att gälla om produkten ändras utan vårt tillstånd.

**DK EU Overensstemmelse certifikat**

Undertegnede Husqvarna AB, 561 82 Huskvarna, Sweden bekræfter hermed, at enheder listede herunder, ved afsendelse fra fabrikken, er i overensstemmelse med harmoniserede EU retningslinier, EU sikkerheds standarder og produkt specifikations standarder. Dette certifikat træder ud af kraft hvis enhederne er ændret uden vor godkendelse.

**FI EU-yhdenmukaisuusvakuutus**

Allerkirjoittanut Husqvarna AB, 561 82 Huskvarna, Sweden vakuuttaa, että allamainitut laitteet täyttävät tehtäiltämme lähtiesään yhdenmukaistettujen EU-direktiivien, EU-turvallisuusstandardien ja tuotekohtaisten standardien vaatimukset. Laitteisiin tehdyt muutokset joista ei ole sovittu kanssamme, johtavat tämän vakuutuksen raukeamiseen.

**I Dichiarazione di conformità alle norme UE**

La sottoscritta Husqvarna AB, 561 82 Huskvarna, Sweden certifica che il prodotto qui di seguito indicato, nei modelli da noi commercializzati, è conforme alle direttive armonizzate UE nonché agli standard di sicurezza e agli standard specifici di prodotto. Qualunque modifica apportata al prodotto senza nostra specifica autorizzazione invalida la presente dichiarazione.

**E Declaración de conformidad de la UE**

El que suscribe Husqvarna AB, 561 82 Huskvarna, Sweden declara que la presente mercancía, objeto de la presente declaración, cumple con todas las normas de la UE, en lo que a normas técnicas, de homologación y de seguridad se refiere. En caso de realizar cualquier modificación en la presente mercancía sin nuestra previa autorización, esta declaración pierde su validez.

**P Certificado de conformidade da UE**

Os abaixo mencionados Husqvarna AB, 561 82 Huskvarna, Sweden Por este meio certificam que ao sair da fábrica osaparelhos abaixo mencionados estão de acordo com as diretrizes harmonizadas da UE, padrões de segurança e de produtos específicos. Este certificado ficará nulo se as unidades forem modificadas sem a nossa aprovação.

**PL Deklaracja zgodności Unii Europejskiej**

Husqvarna AB, 561 82 Huskvarna, Sweden potwierdza, że poniżej określone urządzenia w wersji oferowanej przez nas do sprzedaży spełniają wymagania zharmonizowanych dyrektyw Unii Europejskiej, standardu bezpieczeństwa Unii Europejskiej i standardu specyficznego dla tego typu produktów. W przypadku zmiany urządzenia, która nie została z nami uzgodniona, niniejsza deklaracja traci moc obowiązywania.

**HU EU-Megfelelőségi nyilatkozat**

Alulírott, a Husqvarna AB, 561 82 Huskvarna, Sweden igazolja azt, hogy az alábbiakban megnevezett készülékek, az általunk forgalomba hozott kivitelben teljesítik a harmonizációs EU-irányelvek, az EU biztonsági szabványok és a termékre jellemző szabványok követelményeit. Ha a készülékek a mi belegegyezésünk nélkül változtatást végeznek, akkor ez a nyilatkozat érvényét veszti.

**CZ Prohlášení o shodě EU**

Podepsaný Husqvarna AB, 561 82 Huskvarna, Sweden potvrzuje, že dále uvedené přístroje v námi do provozu uvedeném provedení splňují požadavky harmonizovaných směrnic EU, bezpečnostních norem EU a norem specifických pro výrobek. Při námi neschválené změně přístrojů ztrácí toto prohlášení platnost.

**SK EU-Vyhlasenie o zhode**

Nižšie uvedená firma Husqvarna AB, 561 82 Huskvarna, Sweden vyhlasuje, že uvedené zariadenia, ktoré uviedla na trhu v tomto vyhotovení, splňajú požiadavky harmonizovaných smerníc EU, bezpečnostných noriem EU a noriem špecifických pre výrobok. Pri zmene zariadenia, ktorá nebola odsúhlasená výrobcom stráca toto vyhlásenie platnosť.



**GR Δήλωση Συμμόρφωσης προς τις Οδηγίες της ΕΕ**

H υπογράφουσα Husqvarna AB, 561 82 Huskvarna, Sweden δηλώνει, ότι τα εξής αναφερόμενα εκδιδόμενα από την εταιρία μας προϊόντα ανταποκρίνονται σε όλες τις εναρμονισμένες προδιαγραφές της ΕΕ, στα πρότυπα ασφαλείας της ΕΕ και στα ειδικά για το προϊόν πρότυπα. Σε μία μη συμφωνημένη με την εταιρία μας τροποποίηση των συσκευών αυτή η δήλωση χάνει την ισχύ της.

**EU EV-izjava o skladnosti**

Podpisani proizvajalec »Husqvarna AB, 561 82 Huskvarna, Sweden« s podpisom potrjuje, da sledeče opisana naprava, ki smo jo poslali na tržišče izpolnjuje zahteve harmoniziranih standardov ES-smernic, ES-varnostnih standardov in izdelku specifičnih standardov. V primeru spremembe na napravi brez našega pisnega dovoljenja ta izjava izgubi svoj pomen in veljavnost.

**HR Izjava o sukladnosti EU-a**

Dolje potpisana tvrtka Husqvarna AB, 561 82 Huskvarna, Sweden ovime potvrđuje da dolje navedeni uredaji u izvedbi plasiranoj na tržište ispunjavaju zahtjeve harmoniziranih EU smjernica, EU sigurnosnih normi i normi za određene proizvode. Ova izjava postaje ništavna u slučaju izmjene uredaja koje nismo odobrili.

**RO UE-Certificat de conformitate**

Prin prezenta Husqvarna AB, 561 82 Huskvarna, Sweden, certifica faptul ca, in momentul in care produsele mentionate mai jos ies din fabrica sunt in concordanta cu directivele UE, standardele de siguranta UE si standardele specifice ale produsului UE. Acest certificat devine nul in cazul modificării aparatului fără aprobarea noastră.

**BG ЕС-Декларация за съответствие**

Подписаната фирма Husqvarna AB, 561 82 Huskvarna, Sweden декларира, че описаните по-долу уреди, пуснати в продажба съгласно нашата спецификация, изпълняват изискванията на хармонизираните ЕС-директиви, ЕС-стандартите за безопасност и специфичните производствени стандарти. При промяна на уреда, която не е съгласувана с нас, тази декларация губи своята валидност.

**EE Eli vastavusdeklaratsioon**

Allakirjutanu Husqvarna AB, 561 82 Huskvarna, Sweden kinnitab, et kirjeldatud seade vastab meie poolt ringlusse viidud kujul ELi harmoniseeritud direktiividele, ELi ohutusstandarditele ja tootega seotud standarditele. Meiega kooskõlastamata muudatuse tegemise korral seadmel kaotab see deklaratsioon kehtivuse.

**LV ES Atitikties deklaracija**

Pasirašanti jmonē Husqvarna AB, 561 82 Huskvarna, Sweden patvirtina, kad žemiau nurodyti prietaisai ir jų modeliai, kurie buvo pagaminti mūsų gamyklose atitinka ES direktyvas, ES saugumo standartus ir specifinius gaminio standartus. Atitikus bet kokį prietaiso pakaitimą, kuris nėra suderintas su mumis, ši deklaracija praranda galiojimą.

**LV ES-atbilstības deklaracija**

Parakstījusies Husqvarna AB, 561 82 Huskvarna, Sweden, Vācija apstiprina, ka sekojoši apzīmētās iekārtas, kuras mēs izplatām, savā izpildījumā atbilst harmonizētajām ES direktīvām, ES drošības standartiem un produkta specifiskajiem standartiem. Ar mūsu neapstiprinātām izmaiņām iekārtā šī deklarācija zaudē savu derīgumu.

Bezeichnung der Geräte:	<b>Wechselaccu</b>	Typ:	Art.-Nr.:
Description of the units:	<b>Replacement Battery</b>	Type:	Art. No.:
Désignation du matériel :	<b>Batterie remplaçable</b>	Type :	Référence :
Omschrijving van de apparaten:	<b>Wisselaccu</b>	Typ:	Art.nr.:
Produktbeskrivning:	<b>Utbytes Batteri</b>	Typ:	Art.nr.:
Beskrivelse af produktet:	<b>Batteri</b>	Typ:	Art. nr.:
Laitteiden nimitys:	<b>Vara-akku</b>	Tuoppi:	Tuoten:o
Descrizione dei prodotti:	<b>Batteria di ricambio</b>	Modello:	Art.:
Descripción de la mercancía:	<b>Batería de sustitución</b>	Tipo:	Art. No:
Descrição dos aparelhos:	<b>Acumulador de substituição</b>	Tipo:	Art. no:
Nazwa urządzenia:	<b>Akumulator</b>	Typ:	Nr artykułu:
A készülék megnevezése:	<b>Csereakkumulátor</b>	Typusok:	Cikkszám:
Označení přístrojů:	<b>Náhradní akumulátor</b>	Typ:	Číslo artiklu:
Označenie zariadenia:	<b>Náhradný akumulátor</b>	Typ:	Art.:
Όνομασία της συσκευής:	<b>Ανταλλακτική μπαταρία</b>	Τύποι:	Αριθ. είδους:
Opis naprave:	<b>Nadomestni akumulator</b>	Tip:	Art št.:
Oznaka uređaja:	<b>Zamjenska accu baterija</b>	Tipovi:	br. art.
Descrierea articolelor:	<b>Baterie rezervă</b>	Tip:	Nr art.:
Обозначение на уредите:	<b>Сменями батерии</b>	Тип:	Арт. номер:
Seadmete nimetus:	<b>Vahetusaku</b>	Mudel:	Toote nr:
Prietaisų pavadinimas:	<b>Keičiamas akumuliatorius</b>	Tipas:	Gaminio nr.:
lekārta apzīmējums:	<b>Maināmais akumulators</b>	Modelis:	Izstr.:
		<b>Bli-18</b>	<b>Art. 9839</b>
		Hinterlegte Dokumentation: GARDENA Technische Dokumentation, M. Kugler, 89079 Ulm	
		Deposited Documentation: GARDENA Technical Documentation, M. Kugler, 89079 Ulm	
		Documentation déposée: Documentation technique GARDENA, M. Kugler, 89079 Ulm	



**Deutschland / Germany**

GARDENA Manufacturing GmbH  
Central Service  
Hans-Lorenser-Straße 40  
D-89079 Ulm  
Produktfragen:  
(+49) 731 490-123  
Reparaturen:  
(+49) 731 490-290  
service@gardena.com

**Albania**

COBALT Sh.p.k.  
Rr. Siri Kodra  
1000 Tirana

**Argentina**

Husqvarna Argentina S.A.  
Av. del Libertador 5954 –  
Piso 11 – Torre B  
(C1428AR) Buenos Aires  
Phone: (+54) 11 5194 5000  
info.gardena@ar.husqvarna.com

**Armenia**

Garden Land Ltd.  
61 Tigran Mets  
0005 Yerevan

**Australia**

Husqvarna Australia Pty. Ltd.  
Locked Bag 5  
Central Coast BC  
NSW 2252  
Phone: (+61) (0) 2 4352 7400  
customer.service@  
husqvarna.com.au

**Austria / Österreich**

Husqvarna Austria GmbH  
Industriezeile 36  
4010 Linz  
Tel. : (+43) 732 77 01 01-485  
service.gardena@  
husqvarnagroup.com

**Azerbaijan**

Firm Progress  
a. Aliyev Str. 26A  
1052 Baku

**Belgium**

Husqvarna België nv/sa  
Gardena Division  
Rue Egide Van Ophem 111  
1180 Uccle / Ukkel  
Tel.: (+32) 2 720 92 12  
Mail: info@gardena.be

**Bosnia / Hercegovina**

SILK TRADE d.o.o.  
Industrijska zona Bukva bb  
74260 Tešanj

**Brazil**

Husqvarna do Brasil Ltda  
Av. Francisco Matarazzo,  
1400 – 19<sup>a</sup> andar  
São Paulo – SP  
CEP: 05001-903  
Tel: 0800-112252  
marketing.br.husqvarna@  
husqvarna.com.br

**Bulgaria**

AGROLAND България АД  
бул. 8 Декември, № 13  
Офис 5  
1700 Студентски град  
София  
Тел.: (+359) 24666910  
info@agroland.eu

**Canada / USA**

GARDENA Canada Ltd.  
100 Summerlea Road  
Brampton, Ontario L6T 4X3  
Phone: (+1) 905 792 93 30  
info@gardenacanada.com

**Chile**

Maquinarias Agroforestales  
Ltda. (Maga Ltda.)  
Santiago, Chile  
Avda. Chesterton  
# 8355 comuna Las Condes  
Phone: (+56) 2 202 4417  
Dalton@maga.cl  
Zipcode: 7560330

**China**

Husqvarna (China) Machinery  
Manufacturing Co., Ltd.  
No. 1355, Jia Xin Rd.,  
Ma Lu Zhen, Jia Ding Dist.,  
Shanghai  
201801  
Phone: (+86) 21 59159629  
Domestic Sales  
www.gardena.com.cn

**Colombia**

Husqvarna Colombia S.A.  
Calle 18 No. 68 D-31, zona  
Industrial de Montevideo  
Bogotá, Cundinamarca  
Tel. 571 2922700 ext. 105  
jairo.salazar@husqvarna.com.co

**Costa Rica**

Compania Exim  
Euroberoamericana S.A.  
Los Colegios, Moravia,  
200 metros al Sur del Colegio  
Saint Francis – San José  
Phone: (+506) 297 68 83  
exim\_euro@racsa.co.cr

**Croatia**

SILK ADRIA d.o.o.  
Josipa Lončara 3  
10090 Zagreb  
Phone: (+385) 1 3794 580  
silk.adria@zg.t-com.hr

**Cyprus**

Mep Marketing  
17 Digeni Akrita Ave  
P.O. Box 27017  
1641 Nicosia

**Czech Republic**

Husqvarna Česko s.r.o.  
Türkova 2319/5b  
149 00 Praha 4 – Chodov  
Bezplatná infolinka :  
800 100 425  
servis@cz.husqvarna.com

**Denmark**

GARDENA DANMARK  
Lejrvej 19, st.  
3500 Værløse  
Tlf.: (+45) 70 26 47 70  
husqvarna@husqvarna.dk  
www.gardena.com / dk

**Dominican Republic**

BOSQUESA, S.R.L  
Carretera Santiago Lacey  
Km. 5 ½  
Esquina Copal II.  
Santiago  
Dominican Republic  
Phone: (+809) 736-0333  
joserbosquesa@claro.net.do

**Ecuador**

Husqvarna Ecuador S.A.  
Arupos E1-181 y 10 de  
Agosto Quito, Pichincha  
Tel. (+593) 22800739  
francisco.jacome@  
husqvarna.com.ec

**Estonia**

Husqvarna Eesti OÜ  
Gardena Division  
Valdeku 132  
Tallinn  
11216, Estonia  
info@gardena.ee

**Finland**

Oy Husqvarna Ab  
Gardena Division  
Lautatarhankatu 8 B / PL 3  
00581 HELSINKI  
info@gardena.fi

**France**

Husqvarna France  
9/11 Allée des pierres mayettes  
92635 Gennevilliers Cedex  
France  
http : //www.gardena.com/ fr  
N° AZUR: 0 810 00 78 23  
(Prix d'un appel local)

**Georgia**

ALD Group  
Beliashvili 8  
1159 Tbilisi

**Great Britain**

Husqvarna UK Ltd  
Preston Road  
Aycliffe Industrial Park  
Newton Aycliffe  
County Durham  
DL5 6UP  
info.gardena@husqvarna.co.uk

**Greece**

Π.ΠΑΠΑΔΟΠΟΥΛΟΣ ΑΕΒΕ  
Λεωφ. Αθηνών 92  
Αθήνα  
Τ.Κ.104 42  
Ελλάδα

Τηλ. (+30) 210 5193 100  
info@papadopoulos.com.gr

**Hungary**

Husqvarna Magyarország Kft.  
Ezred u. 1-3  
1044 Budapest  
Telefon: (+36) 1 251-4161  
vevoszolgalat.husqvarna@  
husqvarna.hu

**Iceland**

Ó. Jónsson & Kaaber  
Tunguhalsi 1  
110 Reykjavik  
ooj@ojk.is

**Ireland**

Husqvarna UK Ltd  
Preston Road  
Aycliffe Industrial Park  
Newton Aycliffe  
County Durham  
DL5 6UP  
info.gardena@husqvarna.co.uk

**Italy**

Husqvarna Italia S.p.A.  
Via Santa Vecchia 15  
23868 VALMADRERA (LC)  
Phone: (+39) 0341.203.111  
assistenza.italia@it.husqvarna.com

**Japan**  
KAKUICHI Co. Ltd.  
Sumitomo Realty &  
Development Kojimachi  
BLDG., 8F  
5 -1 Nibanncoyo  
Chiyoda-ku  
Tokyo 102-0084  
Phone: (+81) 33 264 4721  
m\_ishihara@kaku-ichi.co.jp

**Kazakhstan**  
LAMED Ltd.  
155/1, Tazhibayevoy Str.  
050060 Almaty  
IP Schmidt  
Abayavenue 3B  
110 005 Kostanay

**Korea**  
Kyung Jin Trading CO.,LTD.  
107-4, SunDuk Bid.,  
YangJae-dong,  
Seocho-gu,  
Seoul, (zipcode: 137-891)  
Phone: (+82) (0)2 574-6300

**Kyrgyzstan**  
Alye Maki  
av. Moladaya Gujdir J 3  
720014  
Bishkek

**Latvia**  
Husqvarna Latvija SIA  
Gardena Division  
Ulbrokas 19A  
LV-1021 Riga  
info@gardena.lv

**Lithuania**  
UAB Husqvarna Lietuva  
Gardena Division  
Ateities pl. 77C  
LT-52104 Kaunas  
info@gardena.lt

**Luxembourg**  
Magasins Jules Neuberg  
39, rue Jacques Stas  
Luxembourg-Gasperich 2549  
Case Postale No. 12  
Luxembourg 2010  
Phone: (+352) 40 14 01  
api@neuberg.lu

**Mexico**  
AFOSA  
Av. Lopez Mateos Sur # 5019  
Col. La Calma 45070  
Zapopan, Jalisco, Mexico  
Phone: (+52) 33 3818-3434  
icomero@afosa.com.mx

**Moldova**  
Convel S.R.L.  
290A Muncesti Str.  
2002 Chisinau

**Netherlands**  
Husqvarna Nederland B.V.  
GARDENA Division  
Postbus 50131  
1305 AC ALMERE  
Phone: (+31) 36 521 00 10  
info@gardena.nl

**Neth. Antilles**  
Jonka Enterprises N.V.  
Sta. Rosa Weg 196  
P.O. Box 8200  
Curaçao  
Phone: (+599) 9 767 66 55  
pgm@jonka.com

**New Zealand**  
Husqvarna New Zealand Ltd.  
PO Box 76-437  
Manukau City 2241  
Phone: (+64) (0) 9 9202410  
support.nz@husqvarna.co.nz

**Norway**  
Husqvarna Norge AS  
Gardena Division  
Trøskeneveien 36  
1708 Sarpsborg  
Tel: 69 10 47 00  
www.gardena.no

**Peru**  
Husqvarna Perú S.A.  
Jr. Ramón Cárcamo 710  
Lima 1  
Tel: (+51) 1 3320400 ext. 416  
juan.remuzgo@husqvarna.com

**Poland**  
Husqvarna  
Poland Spółka z o.o.  
ul. Wysockiego 15 b  
03-371 Warszawa  
Phone: (+48) 22 330 96 00  
gardena@husqvarna.com.pl

**Portugal**  
Husqvarna Portugal, SA  
Lagoa - Albarraque  
2635 - 595 Rio de Mouro  
Tel.: (+351) 21 922 85 30  
Fax : (+351) 21 922 85 36  
info@gardena.pt

**Romania**  
Madex International Srl  
Soseaua Odaii 117 - 123,  
RO 013603 Bucuresti, S1  
Phone: (+40) 21 352.76.03  
madex@ines.ro

**Russia / Россия**  
ООО „Хускварна“  
141400, Московская обл.,  
г. Химки,  
улица Ленинградская,  
владение 39, стр.6  
Бизнес Центр  
„Химки Бизнес Парк“,  
помещение ОВ02\_04  
http://www.gardena.ru

**Serbia**  
Domel d.o.o.  
Autoput za Novi Sad bb  
11273 Belgrade  
Phone: (+381) 1 18 48 88 12  
miroslav.jejina@domel.rs

**Singapore**  
Hy-Ray PRIVATE LIMITED  
40 Jalan Pemimpin  
#02-08 Tat Ann Building  
Singapore 577185  
Phone: (+65) 6253 2277  
shiyang@hyray.com.sg

**Slovak Republic**  
Husqvarna Česko s.r.o.  
Türkova 2319/5b  
149 00 Praha 4 – Chodov  
Bezplatná infolinka:  
800 154 044  
servis@sk.husqvarna.com

**Slovenia**  
Husqvarna Austria GmbH  
Industriezeile 36  
4010 Linz  
Tel.: (+43) 732 77 01 01-485  
service.gardena@  
husqvarnagroup.com

**South Africa**  
Husqvarna  
South Africa (Pty) Ltd  
Postnet Suite 250  
Private Bag X6,  
Cascades, 3202  
South Africa  
Phone: (+27) 33 846 9700  
info@gardena.co.za

**Spain**  
Husqvarna España S.A.  
Calle de Rivas nº 10  
28052 Madrid  
Phone: (+34) 91 708 05 00  
atencioncliente@gardena.es

**Suriname**  
Agrofix n.v.  
Verlengde Hogestraat #22  
Phone: (+597) 472426  
agrofix@sr.net  
Pobox : 2006  
Paramaribo  
Suriname – South America

**Sweden**  
Husqvarna AB  
Gardena Division  
S-561 82 Huskvarna  
info@gardena.se

**Switzerland / Schweiz**  
Husqvarna Schweiz AG  
Consumer Products  
Industriestrasse 10  
5506 Mägenwil  
Phone: (+ 41) (0) 62 887 37 90  
info@gardena.ch

**Turkey**  
Dost Bahçe Diş Ticaret  
Mümesillik A.Ş  
Yunus Mah. Adil Sok. No: 3  
1c Kapi No: 1 Kartal  
34873 Istanbul  
Phone: (+90) 216 38 93 939  
info@dostbahce.com.tr

**Ukraine / Україна**  
ТОВ «Хусварна Україна»  
вул. Васильківська, 34,  
офіс 204-г  
03022, Київ  
Tel. (+38) 044 498 39 02  
info@uradna.ua

**Uruguay**  
FELI SA  
Entre Rios 1083 CP 11800  
Montevideo – Uruguay  
Tel: (+598) 22 03 18 44  
info@felisa.com.uy

**Venezuela**  
Corporación Casa y Jardín C.A.  
Av. Caroni, Edif. Trezmen, PB.  
Colinas de Bello Monte.  
1050 Caracas.  
Tlf : (+58) 212 992 33 22  
info@casayjardin.net.ve

9839-20.960.01/1016  
© GARDENA Manufacturing GmbH  
D-89070 Ulm  
http://www.gardena.com