

4000/4	Art. 1481
4000/5	Art. 1483
5000/4	Art. 1485
5000/5 Inox	Art. 1487

D Betriebsanleitung

Hauswasserautomat electronic plus mit Trockenlaufsicherung

GB Operating Instructions

Pressure Tank Unit electronic plus with Dry-Running Safety

F Mode d'emploi

Station de pompage automatique electronic plus avec sécurité manque d'eau

NL Instructies voor gebruik

Pomp met hydrofoor electronic plus met droogloopbeveiliging

S Bruksanvisning

Pumpautomat electronic plus med Torrkörningskydd

DK Brugsanvisning

Husvandværk electronic plus med tørløbssikring

I Istruzioni per l'uso

Pompa ad intervento automatico electronic plus con sicurezza contro il funzionamento a secco

E Manual de instrucciones

Bomba automática electronic plus con protección del recorrido en vacío

P Instruções de utilização

Bomba de Pressão electronic plus com protecção contra o funcionamento em seco

FIN Käyttöohje

Painevesiautomaatti electronic plus kuivakäyntisuojailla

N Bruksanvisning

Elektronisk trykkpumpe electronic plus med tørrkjøringssikring

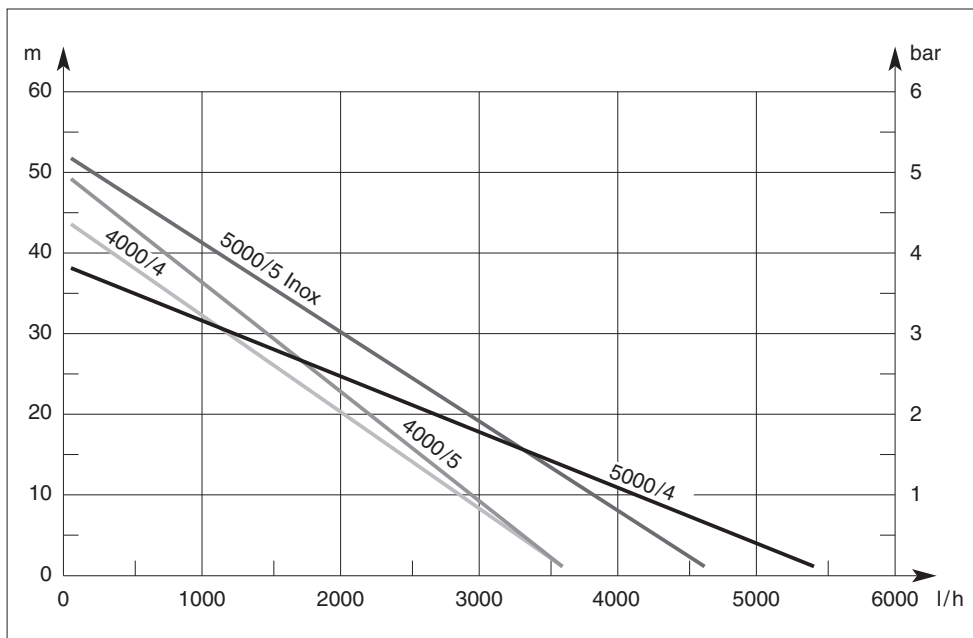

D
Bitte lesen Sie diese Betriebsanleitung vor Inbetriebnahme Ihres Gerätes sorgfältig.

Betriebsanleitung Seite 3-14

GB
Please read these operating instructions carefully before using the unit.

Operating instructions Page 15-25

F
Nous vous remercions de bien vouloir lire attentivement ce mode d'emploi avant l'utilisation de votre pompe.

Mode d'emploi Page 26-37

NL
Lees deze Instructies voor gebruik voor ingebruikname van het apparaat zorgvuldig door.

Instructies voor gebruik Pagina 38-48

S
Läs igenom bruksanvisningen noggrant innan Du tar Din GARDENA Pump i bruk.

Bruksanvisning Sida 49-59

DK
Læs denne brugsanvisning omhyggeligt igennem før montering og igangsætning af apparatet.

Brugsanvisning Side 60-70

I
Prima di mettere in uso la nuova pompa, leggere attentamente le istruzioni.

Istruzioni per l'uso pagina 71-81

E
Antes de la puesta en marcha del aparato, aconsejamos una atenta lectura del presente manual de instrucciones.

Manual de instrucciones Página 82-92

P
Por favor leia atentamente estas instruções de manejo antes de utilizar esta bomba.

Manual de instruções Página 93-104

FIN
Lue tämä käyttöohje ennen laitteesi käyttöönottoa huolellisesti läpi.

Käyttöohje Sivu 105-115

N
Les denne bruksanvisningen nøye igjennom før du setter maskinen i drift.

Bruksanvisning Side 116-126

GARDENA Pressure Tank Unit electronic plus with Dry-Running Safety 4000/4, 4000/5, 5000/4, 5000/5 Inox

Welcome to the Garden of GARDENA ...



Translation of the original instructions from German. Please read these operating instructions carefully and observe the notes given. Use the instructions to familiarise yourself with the equipment, the operating controls, their correct use, and the notes on safety.

⚠ For safety reasons, children under 16 as well as persons not familiar with these operating instructions should not use this Pressure Tank Unit.

Keep these operating instructions in a safe place.

Where to Use Your Pressure Tank Unit

Intended use

GARDENA Pressure Tank Units have been designed for private use around house and garden. Pressure Tank Units are predominantly used for operating watering implements and systems in private gardens.

Liquids to be pumped

The GARDENA Pressure Tank Units can be used for pumping rainwater, tap water or chlorinated swimming pool water.

Please note

⚠ GARDENA Pressure Tank Units are not designed for continuous operation (e.g. industrial application, continuous circulating operation). Corrosive, easily combustible, aggressive or explosive substances (e.g. petrol, petroleum, nitro thinner) as well as food must not be pumped.

Temperature of the liquid

The temperature of the liquid to be pumped should not exceed 35°C.



Safety instructions

Use of pump near swimming pools

Pursuant to DIN VDE 0100-702 and 0100-738 use of the pump nearby swimming pools and garden ponds and other similar places is only permissible, if the pump is operated with a residual-current device with a residual-current rating ≤ 30 mA. The pump must not be operated when there are persons in the swimming pool or garden pond. The pump must be located on solid, even ground, protected from flooding. Take care that the pump cannot fall into water.

→ Please ask your electrician for his advice.

Mains power cables

Mains power cables should not have a smaller cross-section than a rubber sheathed cable of the designation H07 RNF. Extension cables must meet the requirements of DIN VDE 0620.

For Austria

In Austria, the electrical connections must be made according to ÖVE-EM 42, T2 (2000)/1979 § 22 based on § 2022.1. Pursuant to this regulation it's imperative to operate pumps for swimming pools and garden ponds exclusively via an isolating transformer. Please ask your electrician.

For Switzerland

In Switzerland mobile appliances which are used outdoors, must be connected via a residual-current device.

Using the pump for domestic water supply

When using the pump for domestic water supply, please adhere to the local water and sewerage regulations. In addition observe the regulations of DIN 1988. When connecting the pump to the water supply system, the country-specific sanitary regulations must be observed to prevent water not of drinking water quality being drawn back in.

→ If necessary, contact your sanitary expert.

Working environment

Protect the pump from rain. Don't use the pump in wet or moist area.

Visual check

Before operating the pump, first make a visual check, if there is any damage of the pump (esp. regarding power cable and plug). A damaged pump must not be used. In case of damage, please have the pump checked by our GARDENA Service Centre or by an authorised electrician.

Check voltage

Check line voltage. Data indicated on the type plate must match technical data of the mains supply.

Notes on Use

Filter lid and backflow valve lid

Ensure that the filter lid and lid of the backflow valve are screwed on tight during operation.

Never carry the pump by its cable

Don't use the power cable for carrying the pump or for plugging off. Protect the power cable from heat, oil and sharp edges.

Remove plug

Please unplug the pump after operation and before carrying out any maintenance works.

Preventing dry-running

In order to avoid dry-running of the pump, take care that the end of the suction hose is always submerged into the liquid.

Wear and reduction in output

Sand and other abrasive substances in the liquid cause increased wear and reduce the pump's output.

Unsuitable for continuous operation

The pump is not designed for continuous operation (e.g. industrial application, continuous circulating operation).

Minimum flow rate

The minimum flow rate is 90 l/h (= 1.5 l/min). Watering accessories with lower rate must not be operated.

Max. permissible internal pressure

When using the pump for pressure intensification, the max. permissible internal pressure of 6 bar (on the delivery side) must not be exceeded. The to be increased delivery pressure and the pump pressure sum up.

Example: pressure at the water tap 1.5 bar, max. pressure of the GARDENA Pressure Tank Unit 5000/4 electronic plus 3.8 bar, total pressure 5.3 bar.

Recommended Accessories

GARDENA Suction Unit

Art. No. 1411 (3.5 m) / 1418 (7 m)

Vacuum-resistant spiral hose, ready for connection to suction filter and backflow preventer \varnothing 25 mm (1").

GARDENA Suction Hoses

Kink- and vacuum-resistant, sold by the metre with 19 mm (3/4") or 25 mm (1") diameter without fittings or in fixed length, complete with fittings.

Art. No. 1720 19 mm (3/4") or **Art. No. 1721** 25 mm (1")

GARDENA Suction Filter with Backflow Preventer

Art. No. 1726 19 mm (3/4"); **Art. No. 1727** 25 mm (1");

Art. No. 1728 19 mm (3/4") / 25 mm (1")

In metal / plastic.

GARDENA Bore Hole Suction Hose

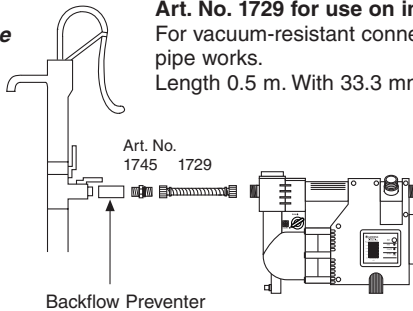

Art. No. 1729 for use on inlet side

For vacuum-resistant connection of the pump to bore holes or pipe works.

Length 0.5 m. With 33.3 mm (G 1) female thread at both ends.

GARDENA Brass Quick Thread Couplings (→ For use on delivery side)

Art. No. 7109 Quick Thread Coupling with 33.3 mm (G1) thread and

Art. No. 7120 Suction and High-Pressure Coupling for 19 mm (3/4") hoses or

Art. No. 7121 for 25 mm (1") hoses in conjunction with a hose clamp **Art. No. 7192**.

Fixed Installation

Fixing Plate

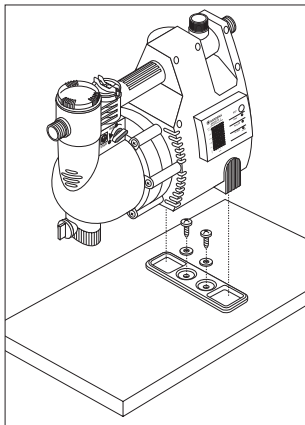

To ensure the pump is stable and to prevent it from slipping, screw the fixing plate supplied onto a suitable surface.

Stand both feet of your Pressure Tank Unit on the fixing plate.

Set up the pump such that a suitably large container can be positioned below the drain screw for emptying the pump or unit.

If possible, install the pump higher than the surface of the water to be pumped.

Note:

If this is not possible, install a vacuum-resistant shut-off device between the pump and the suction hose, for example for cleaning the integrated filter.

Use compression-resistant and flexible hoses

Use flexible, compression-resistant hoses for connection to the fixed installation (→ noise reduction).

Install shut-off valves

For fixed installation, use shut-off devices on both the inlet and delivery sides of the pump
→ important, for example, for maintenance and cleaning or for shutting down the pump.

Delivery Side Connection

Delivery side

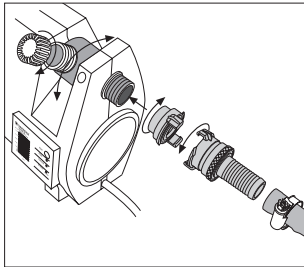

The hose connectors on the inlet side and delivery side must only be tightened by hand.

Connect the hose to the 33.3 mm (G 1) thread on the delivery side:

- To either the 120°-swivel and/or horizontal connection
- Seal the connection which is not required with a cap.

Recommendation:

Use compression-resistant hoses, for example the GARDENA Profi Top Hose, 19 mm (3/4") in diameter, Art. No. 4414 together with the GARDENA Quick Thread Coupling with female thread Art. No. 7109 (with 33.3 mm (G 1) thread) and the GARDENA Suction and High Pressure Coupling Art. No. 7120 (for 19 mm (3/4") hoses) and a GARDENA hose clamp Art. No. 7192.

Optimum delivery capacity

Best results regarding the delivery capacity of the pump are achieved when connecting 19 mm (3/4") hoses.

Inlet Side Connection

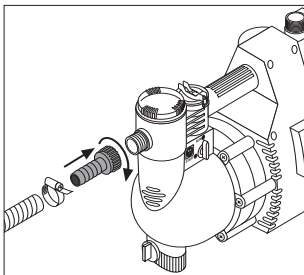

Screw the GARDENA Suction Unit (Art. No. 1411/1418) to the inlet side of the pump and screw tight by hand until the seal is tight. Then submerge the suction hose in the liquid to be pumped.

Fixed Installation:

For connection to pipes or borse holes, we recommend using the GARDENA Borse Hole Suction hose (Art. No. 1729).

Recommendation:

For suction heights exceeding 4 m, we recommend securing the suction hose, e.g. by fastening it to a wooden peg, thus the pump is relieved of load.

Don't use any hose connection system fittings on the inlet side!

Before Operation

Setting Up and Filling the Pump

Position the pump at a safe distance from the liquid to be pumped

The pump must be positioned on a sturdy, dry surface to ensure the pump is stable.

→ Install the pump at a safe distance (min. 2 m) from the pumping medium.

The pump must be installed in a location with low air humidity and sufficient ventilation in the area of the ventilation slots. It must be at a distance of at least 5 cm from the walls. No dirt contamination (e.g. sand or earth) may be sucked in through the ventilation slots.

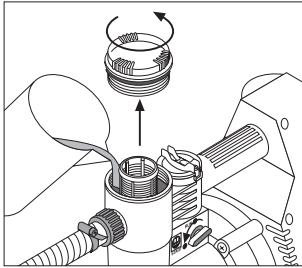

Filling the pump:

- Open the lid of the filter chamber
- Set the switch to **START** (→ the integrated backflow valve is opened)
- Fill the pump completely via the filter chamber with the clean and cold liquid to be pumped.

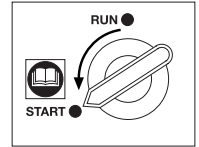

- Use a suction hose with backflow preventer and fill the hose with water to allow the pump to begin pumping the liquid fault-free (see section "Inlet Side Connection").

- Screw the lid of the filter chamber back on.

Putting into Operation

Using the pump for the first time

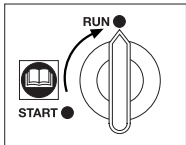
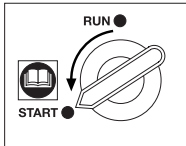

- Set the switch of the backflow valve to **START**.
- Slightly open the release points in the delivery pipe (e.g. spray lance, tap)
→ Air must be allowed to escape during the suction process.
- Plug the mains plug into a socket supplying 230 V AC.

Warning: The pump starts immediately!

As soon as the pump begins to pump, turn the switch to **RUN** (normal operation) → ensures fault-free operation of the pump.

Electronic Control

Pressure tank units are equipped with an electronic control unit with fixed programs.

The electronic control unit is activated by pulses from the manometric switch and the flow recognition of the dry-running

safety feature.

The manometric switch is set at the factory to a switching pressure of approx. 2.2 bar. This setting cannot be changed.

The dry-running safety mechanism protects the pump against

damage and controls the time the pump continues to run against the closed delivery side. The LEDs (light emitting diodes) display the operating status (→ see "Electronic Control Display").

Putting the pump into operation

Manometric switch

- As soon as you plug the mains plug into a socket supplying 230 V AC, the red and green LEDs light up – the pump starts. The pump switches off once the max. pump pressure has been reached (→ the green Pump LED extinguishes).
- If the pressure decreases below the switching pressure of approx. 2.2 bar, the electronic control automatically switches on the pump.
Note: Even the removal of a small quantity of water (several ml) can lead to a pressure drop which is sufficient for the pump to cut in.
- Once you have finished drawing-off water, the maximum pressure is created in the pipe. The pump then continues to run for approx. 10 seconds before switching off.
- The pump is switched off by the manometric switch if the liquid to be pumped fails to flow (→ dry-running safety).

Fault

A fault occurs if water cannot be pumped or if there is a lack of water, for example:

- If the flow rate is less than approx. 90 l/h (→ delivery side throttling)
- If the flow rate is less than approx. 400 l/h (→ inlet side throttling)
- If there is a leak in the system causing the pump to switch on and off more than 7 times within 2 minutes.
- Due to a suction hose without a backflow preventer.

Explanation of Terms

Priming cycle

The pump attempts to restore normal operation in 4 minutes.

Automatic self-priming mode (→ yellow Alarm LED flashes)

After a fault, the pump's electronic control unit makes three automatic self-priming attempts at different time intervals (after 1 hour, after 5 hours and after 20 hours) to restore normal operation. The **priming cycle** (see above) is used for each of these attempts.

Re-plugging (removing the mains plug and then plugging it back in the socket again)

Important! Remove the plug from the socket! Check the unit and pump for any faults (see section "Finding Faults"). Rectify any faults and restart the pump by plugging the mains plug into a socket supplying 230 V AC.

Electronic Control Display

Operating status



lit



flashing



flashing quickly

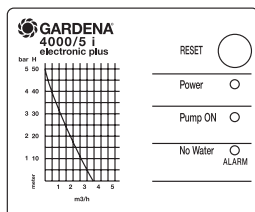

RESET Button

The RESET button is used to reset and restart the pump after a fault.

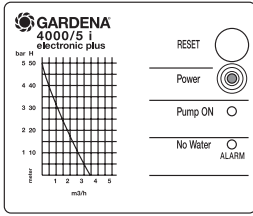

Red Power LED is lit

The pump is connected to the mains power.
The pump functions in the normal operating mode.

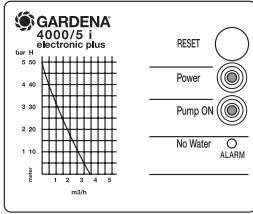

Green LED is lit

The pump is connected to the mains and the pump is running.
Once the pump has reached the max. pump pressure, the pump switches off (the green LED extinguishes) and the pump functions in the normal operating mode.

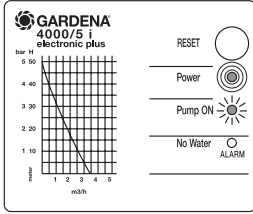

Green LED flashing slowly (once a second)

- The flow rate **on the delivery side** is too low (below 90 l/h).
The pump continues to run and then switches off. It turns on again as soon as the switching pressure of approx. 2.2 bar has been reached (e.g. in the case of a leak).
- The pump must be switched off just before you finish draining water from the unit.

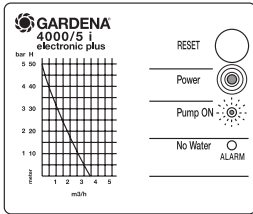

Green LED flashing quickly (four times a second)

- The flow rate **on the inlet side** is too low (below 400 l/h).
The pump continues to run for approx. 40 seconds. If normal operation is not achieved during this time, the pump switches off and the control unit changes to the **“automatic self-priming mode”**.
Note: The pump can be switched on again at any time by pressing the RESET button..

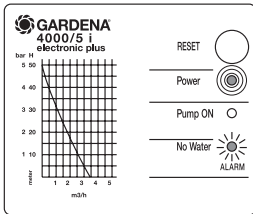

Yellow LED flashing slowly (once a second)

- The amount of water is too low when restarting the pump.
The pump runs through the first **“priming cycle”**. If the normal operating mode is not achieved, the pump switches off and the control unit changes to the **“auto-matic self-priming mode”**.
Note: The pump can be restarted at any time by pressing the RESET button.

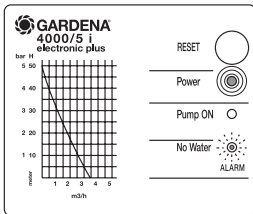

Yellow LED flashing quickly (four times a second)

- Alarm which indicates if the amount of water is too low when the pump is operating in the normal mode. The control unit changes to the **“automatic self-priming mode”**.
Note: The pump can be restarted at any time by pressing the RESET button.

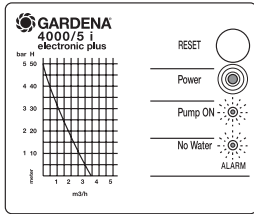
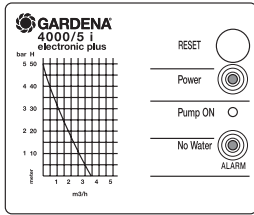

Yellow LED is lit

- The “**automatic self-priming mode**” is no longer active and the unit is no longer supplying water (e.g. no water in the container or borse or the filter is dirty).

Note: The pump can be restarted at any time by pressing the RESET button or by “**re-plugging**”.

Green and yellow LEDs flashing quickly and alternately (four times a second)

- **Warning:** There is a leak in the pipe system.

The pump switches on and off because of a leak. If the pump switches on and off more than 7 times within 2 minutes, the control unit issues a warning via flashing LEDs and the motor switches itself off.

Note: The pump can only be restarted by “**re-plugging**”.

Finding Faults

Important!

Unplug the pump. Check the pump for possible faults such as:

- Faulty or leaking back-flow preventer at the end of the suction hose
- Pump and suction hose are not filled up with the liquid to be pumped
- Backflow valve switch set to **START** and was not set to **RUN** once the pump began pumping

- Suction hose end is not submerged into the liquid
- Outlet too low
- Suction hose or connections are not water-tight
- Suction filter clogged
- Air cannot escape on delivery side since release points are closed etc.
- Delivery pipe or consumer are not water-tight
- The pump switches on and off because of a leak. If the pump switches on and off more than 7 times within

2 minutes, the control unit issues a warning via flashing LEDs and the motor switches itself off.

Clear the fault. Plug in the pump in order to start again operation of the pump.

Shouldn't the pump start priming, although you have repeatedly pressed the **RESET** button, please contact one of our GARDENA Service Centres (addresses you will find on the rear side).

Storing Your Pressure Tank Unit

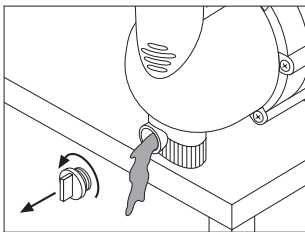

Always remove the mains plugs before working on the pump.

Protect your pump against frost.

- Set the switch to **START** and empty the pump via the drain screw.
- Store you pump away from frost.

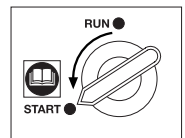

Disposal

(in accordance with RL 2002/96/EC)



The product must not be added to normal household waste. It must be disposed of in line with local environmental regulations.

- **Important:** Make sure that the unit is disposed of via your municipal recycling collection centre.

Cleaning the Integrated Filter

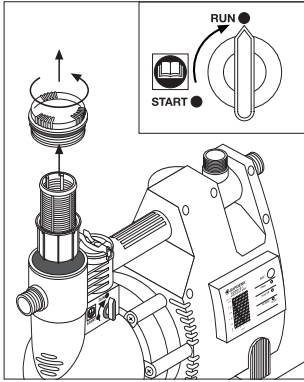

Always remove the mains plugs before working on the pump.

- Set or leave the switch on **RUN**.
- If necessary, close the shut-off device on the inlet side of the pump.
- Unscrew the filter lid by turning anti-clockwise.
- Remove the filter unit by pulling vertically upwards.
- Hold the container and remove the filter from the bayonet socket by turning anti-clockwise.
- Rinse the container under running water and clean the filter using a soft brush, for example.
- Reassemble the container-filter unit in reverse order.
- Insert the cleaned filter unit into the pump.
- Screw on the filter lid until tight.

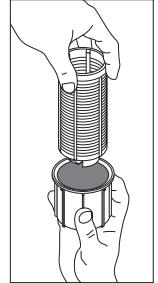
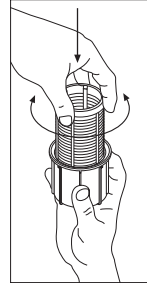

Cleaning the Integrated Back-Flow Valve

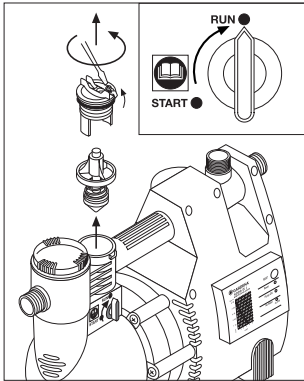

Always remove the mains plugs before working on the pump.

- Set or leave the switch on **RUN**.
-  Ensure that the delivery side is de-pressurised, for example, by opening the consumers.
- Close any shut-off devices on the inlet and delivery side.
- Loosen the screw by turning it anti-clockwise until you can push the holder upwards and backwards into opening position.
- Remove the lid of the integrated back-flow valve by turning anti-clockwise.
- Remove the valve body and rinse under clean running water.
- After cleaning, replace the valve body centrally in the correct position (cone point downwards).
- Screw on the lid until tight.
- Push the holder forwards and position it in its original position. Then tighten the screw again by turning it clockwise.

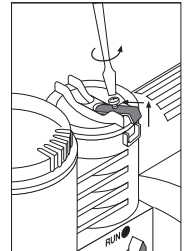

Trouble-Shooting

Problem	Probable cause	Remedy
Pump motor runs, but delivery capacity or pressure suddenly decreases	Leaks at suction side.	Eliminate leak.
	Suction filter on suction hose is partially or entirely exposed.	Throttle the pump on the delivery side to adjust the flow rate of the inlet side to the rate of the delivery side. Observe min. flow rate (see "Technical Data").
	Suction filter or backflow preventer clogged.	Clean filter or backflow preventer.
Pump doesn't deliver water	Leaks at suction side.	Eliminate leak.
Pump switches on and off continuously if liquid is drawn at a rate greater than 400 l/h	Dirt has collected on the impeller of the manometric switch.	1. Return valve set to position 2 . 2. Rinse Pump.
Pump doesn't start or suddenly stops during operation	No power.	Check fuses and electric connections.
	Circuit breaker has cut out the pump because of overloading.	Observe max. liquid temperature (35 °C).
	Electric failure.	Send the pump to one of our GARDENA Service Centres.
Pump switches on and off without drawing-off water for long intervals	Leak on the pressure side.	Check the pressure line and connected consumers for leaks. The non-return valve shall be at position RUN when localising faults. <u>Note:</u> Even the smallest leak (loss of a few ml) can cause the pressure in the pump to drop. The cause of this is often small leaks at taps and toilet flushing cisterns.
Pump permanently switches on and off after drawing off water	Switch / backflow valve set to START .	Set the switch to RUN .
	Larger leaks on the pressure side.	Rectify leaks.
Pump doesn't start working	Outlet end (e.g. water accessory) is closed. There is sufficient water pressure in the pressure line.	Open the outlet end.

If you have any problems with your Pressure Tank Unit, please contact our Service or return the defective unit together with a short description of the problem – in case of guarantee, with a copy of the receipt – postage paid to one of the GARDENA Service Centres listed on the back of this leaflet.

Technical Data

Type	4000/4	4000/5	5000/4	5000/5 Inox
Art. No.	1481	1483	1485	1487
Rated power	800 W	1,000 W	800 W	1,300 W
Max. delivery capacity	3,600 l/h	3,600 l/h	5,400 l/h	4,600 l/h
Max. delivery head	44 m	50 m	38 m	52 m
Max. pressure (= cut-out pressure)	4.4 bar	5.0 bar	3.8 bar	5.2 bar
Cut-in pressure approx.	2.2 ±0,2 bar	2.2 ±0,2 bar	2.2 ±0,2 bar	2.2 ±0,2 bar
Max. suction head	9 m	9 m	8 m	9 m
Perm. internal pressure (delivery side)	6 bar	6 bar	6 bar	6 bar
Max. media temperature	35 °C	35 °C	35 °C	35 °C
Power cable	1.5 m H07 RNF	1.5 m H07 RNF	1.5 m H07 RNF	1.5 m H07 RNF
Mains voltage	230 V	230 V	230 V	230 V
Frequency	50 Hz	50 Hz	50 Hz	50 Hz
Weight	10.5 kg	11 kg	11 kg	13 kg
Noise level L_{WA} ¹⁾	measured 74 dB(A)	measured 76 dB(A)	measured 74 dB(A)	measured 80 dB(A)
	guaranteed 75 dB(A)	guaranteed 79 dB(A)	guaranteed 77 dB(A)	guaranteed 81 dB(A)

1) Measuring method according to directive 2000/14/EC

Performance Characteristics (see cover)

Technical data of the above performance characteristics is measured at a suction height of 0.5 m, using a 25 mm (1") suction hose.

Service / Warranty

GARDENA guarantees this product for 2 years (from date of purchase). This guarantee covers all serious defects of the unit that can be proved to be material or manufacturing faults. Under warranty we will either replace the unit or repair it free of charge if the following conditions apply:

- The unit must have been handled properly and in keeping with the requirements of the operating instructions.
- Neither the purchaser or a non-authorised third party have attempted to repair the unit.

The impeller and the filter are wearing parts and are not covered by the guarantee.

This manufacturer's guarantee does not affect the user's existing warranty claims against the dealer/seller.

If a fault occurs with your Garden Pump, please return the faulty unit together with a copy of the receipt and a description of the fault, with postage paid to one of the GARDENA Service Centres listed on the back of these operating instructions.

<p>D <i>Produkthftung</i></p>	<p>Wir weisen ausdrücklich darauf hin, dass wir nach dem Produkthaftungsgesetz nicht für durch unsere Geräte hervorgerufene Schäden einzustehen haben, sofern diese durch unsachgemäße Reparatur verursacht oder bei einem Teileaustausch nicht unsere Original GARDENA Teile oder von uns freigegebene Teile verwendet werden und die Reparatur nicht vom GARDENA Service oder dem autorisierten Fachmann durchgeführt wird. Entsprechendes gilt für Ergänzungsteile und Zubehör.</p>
<p>GB <i>Product Liability</i></p>	<p>We expressly point out that, in accordance with the product liability law, we are not liable for any damage caused by our units if it is due to improper repair or if parts exchanged are not original GARDENA parts or parts approved by us, and, if the repairs were not carried out by a GARDENA Service Centre or an authorised specialist. The same applies to spare parts and accessories.</p>
<p>F <i>Responsabilité</i></p>	<p>Nous vous signalons expressément que GARDENA n'est pas responsable des dommages causés par ses appareils, dans la mesure où ces dommages seraient causés suite à une réparation non conforme, dans la mesure où, lors d'un échange de pièces, les pièces d'origine GARDENA n'auraient pas été utilisées, ou si la réparation n'a pas été effectuée par le Service Après-Vente GARDENA ou l'un des Centres SAV agréés GARDENA. Ceci est également valable pour tout ajout de pièces et d'accessoires autres que ceux préconisés par GARDENA.</p>
<p>NL <i>Productaansprakelijkheid</i></p>	<p>Wij wijzen er nadrukkelijk op, dat wij op grond van de wet aansprakelijkheid voor producten niet aansprakelijk zijn voor schade ontstaan door onze apparaten, indien deze door onvakkundige reparatie veroorzaakt zijn, of er bij het uitwisselen van onderdelen geen gebruik gemaakt werd van onze originele GARDENA onderdelen of door ons vrijgegeven onderdelen en de reparatie niet door de GARDENA technische dienst of de bevoegde vakman uitgevoerd werd. Ditzelfde geldt voor extra-onderdelen en accessoires.</p>
<p>S <i>Produktansvar</i></p>	<p>Tillverkaren är inte ansvarig för skada som orsakats av produkten om skadan beror på att produkten har reparerats felaktigt eller om, vid reparation eller utbyte, andra än Original GARDENA reservdelar har använts. Samma sak gäller för kompletteringsdelar och tillbehör.</p>
<p>DK <i>Produktansvar</i></p>	<p>Vi gør udtrykkeligt opmærksom på at i henhold til produktansvarsloven er vi ikke ansvarlige for skader forårsaget af vores udstyr, hvis det skyldes uautoriserede reparationer eller hvis dele er skiftet ud og der ikke er anvendt originale GARDENA dele eller dele godkendt af os, eller hvis reparationerne ikke er udført af GARDENA-service eller en autoriseret fagmand. Det samme gælder for ekstra udstyr og tilbehør.</p>
<p>I <i>Responsabilità del prodotto</i></p>	<p>Si rende espressamente noto che, conformemente alla legislazione sulla responsabilità del prodotto, non si risponde di danni causati da nostri articoli se originati da riparazioni eseguite non correttamente o da sostituzioni di parti effettuate con materiale non originale GARDENA o comunque da noi non approvato e, in ogni caso, qualora l'intervento non venga eseguito da un centro assistenza GARDENA o da personale specializzato autorizzato. Lo stesso vale per le parti complementari e gli accessori.</p>
<p>E <i>Responsabilidad de productos</i></p>	<p>Advertimos que conforme a la ley de responsabilidad de productos no nos responsabilizamos de daños causados por nuestros aparatos, siempre y cuando dichos daños hayan sido originados por arreglos o reparaciones indebidas, por recambios con piezas que no sean piezas originales GARDENA o bien piezas autorizadas por nosotros, así como en aquellos casos en que la reparación no haya sido efectuada por un Servicio Técnico GARDENA o por un técnico autorizado. Lo mismo es aplicable para las piezas complementarias y accesorios.</p>
<p>P <i>Responsabilidade sobre o produto</i></p>	<p>Queremos salientar que segundo a lei da responsabilidade do fabricante, nós não nos responsabilizaremos por danos causados pelo nosso equipamento, quando estes ocorram em decorrência de reparações inadequadas ou da substituição de peças por peças não originais da GARDENA, ou peças não autorizadas. A responsabilidade tornar-se-à nula também depois de reparações realizadas por oficinas não autorizadas pela GARDENA. Esta restrição valerá também para peças adicionais e acessórios.</p>

FIN Tuotevastuu	Korostamme nimenomaan, että tuotevastuulain nojalla emme ole vastuussa laitteistamme johtuneista vahingoista, mikäli nämä ovat aiheutuneet epäasianmukaisesta korjauksesta tai osia vaihdettaessa ei ole käytetty alkuperäisiä GARDENA- varaosia tai hyväksymiämme osia ja korjauksen on suorittanut muu kuin GARDENA -huoltokeskus tai valtuuttamamme ammattihenkilö. Tämä pätee myös lisäosiin ja lisävarusteisiin.
N Produktansvar	Vi gjør uttrykkelig oppmerksom på at vi i henhold til produktansvarsloven ikke er ansvarlige for skader forårsaket av redskapet vårt hvis dette skyldes usakkyndige reparasjoner eller hvis deler er skiftet ut og det ikke ble benyttet våre originale GARDENA deler eller deler som er godkjent av oss og reparasjonen ikke er utført av GARDENA service eller den autoriserte fagmannen. Det samme gjelder for supplerende deler og tilbehør.

D EU-Konformitätserklärung Maschinenverordnung (9. GSGVO) / EMVG / Niedersp. RL Der Unterzeichnete GARDENA Manufacturing GmbH, Hans-Lorenser-Str. 40, D-89079 Ulm, bestätigt, dass die nachfolgend bezeichneten Geräte in der von uns in Verkehr gebrachten Ausführung die Anforderungen der harmonisierten EU-Richtlinien, EU-Sicherheitsstandards und produktspezifischen Standards erfüllen. Bei einer nicht mit uns abgestimmten Änderung der Geräte verliert diese Erklärung ihre Gültigkeit.	Bezeichnung des Gerätes: Hauswasserautomat electronic plus Description of the unit: Pressure Tank Unit electronic plus Désignation du matériel : Station de pompage automatique electronic plus Omschrijving van het apparaat: Pomp met hydrofoor electronic plus Produktbeschreibung: Pumpautomat electronic plus Beskrivelse af enhederne: Husvandværk electronic plus Descrizione del prodotto: Pompa ad intervento automatico electronic plus Descripción de la mercancía: Bomba automática electronic plus Descrição do aparelho: Bomba de Pressão electronic plus Laitteiden nimitys: Painevesiautomaatti electronic plus Betegnelse for redskapet: Elektronisk trykkpumpe electronic plus
GB EU Certificate of Conformity The undersigned GARDENA Manufacturing GmbH, Hans-Lorenser-Str. 40, D-89079 Ulm, hereby certifies that, when leaving our factory, the units indicated below are in accordance with the harmonised EU guidelines, EU standards of safety and product specific standards. This certificate becomes void if the units are modified without our approval.	Typ: Art.-Nr.: Type: Art. No.: Type : 4000/4 Référence : 1481 Type: Art. nr.: Type: 4000/5 Art.nr. : 1483 Type: Varen. : Modello: 5000/4 Art. : 1485 Tipo: Art. Nº: Tipo: 5000/5 Inox Art. Nº: 1487 Typpit: Art.-n.o.: Typer: Art.-Nr.:
F Certificat de conformité aux directives européennes Le constructeur, soussigné : GARDENA Manufacturing GmbH, Hans-Lorenser-Str. 40, D-89079 Ulm, déclare qu'à la sortie de ses usines le matériel neuf désigné ci-dessous était conforme aux prescriptions des directives européennes énoncées ci-après et conforme aux règles de sécurité et autres règles qui lui sont applicables dans le cadre de l'Union européenne. Toute modification portée sur ce produit sans l'accord express de GARDENA supprime la validité de ce certificat.	EU-Richtlinien: Harmonisierte EN: EU directives: EN 292-1 Directives 98/37/EC : 1998 EN 292-2 européennes : 2006/42/EC : 2006 EN 60335-1 EU-richtlijnen: EN 60335-2-41 EU direktiv : 2006/95/EC EU Retningslinier: 2004/108/EC Direttive UE: 93/68/EC Normativa UE: 2000/14/EC Directrices da UE: 2000/14/EC EY-direktivit: EU-direktiver:
NL EU-overeenstemmingsverklaring Ondergetekende GARDENA Manufacturing GmbH, Hans-Lorenser-Str. 40, D-89079 Ulm, bevestigt, dat het volgende genoemde apparaat in de door ons in de handel gebrachte uitvoering voldoet aan de eis van, en in overeenstemming is met de EU-richtlijnen, de EU-veiligheidsstandaard en de voor het product specifieke standaard. Bij een niet met ons afgestemde verandering aan het apparaat verliest deze verklaring haar geldigheid.	Hinterlegte Dokumentation: GARDENA Technische Dokumentation Konformitätsbewertungsverfahren: Nach 2000/14/EG Art. 14 Anhang V Deposited Documentation: GARDENA Technical Documentation Conformity Assessment according to 2000/14/EC Procedure: Art. 14 Annex V Documentation déposée : Documentation technique GARDENA Procédure d'évaluation de la Selon 2000/14/CE art. 14 Annexe V conformité :
S EU Tillverkarintyg Undertecknad firma GARDENA Manufacturing GmbH, Hans-Lorenser-Str. 40, D-89079 Ulm, intygar härmed att nedan nämnda produkt överensstämmer med EU:s direktiv, EU:s säkerhetsstandard och produktspecifikation. Detta intyg upphör att gälla om produkten ändras utan vårt tillstånd.	
DK EU Overensstemmelse certificat Under tegnede GARDENA Manufacturing GmbH, Hans-Lorenser-Str. 40, D-89079 Ulm bekræfter hermed, at enheder listet herunder, ved afsendelse fra fabrikken, er i overensstemmelse med harmoniserede EU retningslinier, EU sikkerhedsstandarder og produktspecifikationsstandarder. Dette certifikat træder ud af kraft hvis enhederne er ændret uden vor godkendelse.	
I Dichiarazione di conformità alle norme UE La sottoscritta GARDENA Manufacturing GmbH, Hans-Lorenser-Str. 40, D-89079 Ulm, certifica che il prodotto qui di seguito indicato, nei modelli da noi commercializzati, è conforme alle direttive armonizzate UE nonché agli standard di sicurezza e agli standard specifici di prodotto. Qualunque modifica apportata al prodotto senza nostra specifica autorizzazione invalida la presente dichiarazione.	

<p>E Declaración de conformidad de la UE</p> <p>El que subscribe GARDENA Manufacturing GmbH, Hans-Lorenser-Str. 40, D-89079 Ulm, declara que la presente mercancía, objeto de la presente declaración, cumple con todas las normas de la UE, en lo que a normas técnicas, de homologación y de seguridad se refiere. En caso de realizar cualquier modificación en la presente mercancía sin nuestra previa autorización, esta declaración pierde su validez.</p>	<p>Schall-Leistungspegel: gemessen / garantiert Noise level: measured / guaranteed Puissance acoustique : mesurée / garantie Geluidsniveau: gemeten / gegarandeerd Ljudnivå: uppmätt / garanterad Lydtryksniveau: atmått / garanti Livello rumorosità: testato / garantito Nivel sonoro: medido / garantizado Nivel de ruido: medido / garantido Melun tehotosa: mitattu / taattu Lydeffektivität: mått / garantert</p>
<p>P Certificado de conformidade da UE</p> <p>Os abaixo mencionados GARDENA Manufacturing GmbH, Hans-Lorenser-Str. 40, D-89079 Ulm, por este meio certificam que ao sair da fábrica o aparelho abaixo mencionado está de acordo com as directrizes harmonizadas da UE, padrões de segurança e de produtos específicos. Este certificado ficará nulo se a unidade for modificada sem a nossa aprovação.</p>	<p>4000/4 74 dB (A) / 75 dB (A) 4000/5 76 dB (A) / 79 dB (A) 5000/4 74 dB (A) / 77 dB (A) 5000/5 Inox 80 dB (A) / 81 dB (A)</p>
<p>FIN EY-vaatimustenmukaisuusvakuutus</p> <p>Allekirjoittanut GARDENA International GmbH, Hans-Lorenser-Straße 40, D-89079 Ulm vakuuttaa, että allamainitut laitteet täyttävät tehtaaltamme lähtönsään yhdenmukaistettujen EY-direktiivien, EY-turvallisuusstandardien ja tuotekohtaisten standardien vaatimukset. Laitteisiin tehty muutokset, joista ei ole sovittu kanssamme, johtavat tämän vakuutuksen raukeamiseen.</p>	<p>Anbringningsjahr der CE-Kennzeichnung: 1999 Year of CE marking: Date d'apposition du marquage CE : Installatiejaar van de CE-aanduiding: CE-Märkningsår: CE-Mærkningsår: Anno di rilascio della certificazione CE: Colocación del distintivo CE: Ano de marcação pela CE: CE-merkin kiinnitysvuosi: CE-merkingen plassert i:</p>
<p>N EU-samsvarserklæring</p> <p>Den undertegnede GARDENA International GmbH, Hans-Lorenser-Straße 40, D-89079 Ulm erklærer ved dette, at redskapet oppført nedenfor i utførelsen som vi har introdusert på markedet er i samsvar med kravene i de harmoniserte EU-direktivene, EU-sikkerhetsstandarder og produktspesifikke standarder. Ved en endring av redskapet som ikke er avstemt med oss, taper denne erklæringen sin gyldighet.</p>	<p>Ulm, den 12.06.2002 Ulm, 12.06.2002 Fait à Ulm, le 12.06.2002 Ulm, 12.06.2002 Ulm, 2002.12.06. Ulm, 12.06.2002 Ulm, 12.06.2002 Ulm, 12.06.2002 Ulm, 12.06.2002 Ulm, 12.06.2002 Ulm, 12.06.2002 Ulm, 12.06.2002 Ulm, 12.06.2002 Ulm, 12.06.2002</p>
	<p>Der Bevollmächtigte Authorised representative Représentant légal Gemachtigde Behörig Firmatecknare Teknisk direktør Rappresentante autorizzato Representante autorizado Representante autorizado Teknisk direktør Valtutettu edustaja Den fullemektige</p> <p></p> <p>Thomas Heint Technical Dept. Manager</p>

Deutschland / Germany

GARDENA
Manufacturing GmbH
Central Service
Hans-Lorenser-Straße 40
D-89079 Ulm
Produktfragen:
(+49) 731 490-123
Reparaturen:
(+49) 731 490-290
service@gardena.com

Argentina

Husqvarna Argentina S.A.
Vera 745
(C1414AOO) Buenos Aires
Phone: (+54) 11 4858-5000
diego.poggi@ar.husqvarna.com

Australia

Husqvarna Australia Pty. Ltd.
Locked Bag 18
Gosford NSW 2250
Phone: (+61) (0) 2 4372 1500
customer.service@
husqvarna.com.au

Austria / Österreich

Husqvarna Austria GmbH
Consumer Products
Industriezeile 36
4010 Linz
Tel.: (+43) 732 77 01 01 - 90
consumer.service@
husqvarna.at

Belgium

GARDENA Belgium NV/SA
Sterrebeekstraat 163
1930 Zaventem
Phone: (+32) 2 720 92 12
Mail: info@gardena.be

Brazil

Palash Comércio e
Importação Ltda.
Rua São João do Araguaia, 338
- Jardim Califórnia -
Barueri - SP - Brasil -
CEP 06409-060
Phone: (+55) 11 4198-9777
eduardo@palash.com.br

Bulgaria

Хускварна България ЕООД
1799 София
Бул. „Андрей Ляпчев“ № 72
Тел.: (+359) 2 80 99 424
www.husqvarna.bg

Canada

GARDENA Canada Ltd.
100 Summerlea Road
Brampton, Ontario L6T 4X3
Phone: (+1) 905 792 93 30
info@gardenacanada.com

Chile

Antonio Martinic y Cia Ltda.
Cassillas 272
Centro de Cassillas
Santiago de Chile
Phone: (+56) 2 20 10 708
garfar_cl@yahoo.com

Costa Rica

Compania Exim
Euroiberoamericana S.A.
Los Colegios, Moravia,
200 metros al Sur del Colegio
Saint Francis - San José
Phone: (+506) 297 68 83
exim_euro@racsa.co.cr

Croatia

KLIS d.o.o.
Stanceva 79
10419 Vukovina
Phone: (+385) 1 622 777 0
gardena@klis-trgovina.hr

Cyprus

FARMOKIPIKI LTD
P.O. Box 7098
74, Digeni Akritas Ave.
1641 Nicosia
Phone: (+357) 22 75 47 62
condam@spidernet.com.cy

Czech Republic

GARDENA spol. s r.o.
Tuřanka 115
627 00 Brno
Phone: (+420) 548 217 777
gardena@gardenabrn.cz

Denmark

GARDENA
Husqvarna Consumer Outdoor
Products
Salgsafdelning Danmark
Box 9003
S-200 39 Malmö
info@gardena.dk

Estonia

Husqvarna Eesti OÜ
Consumer Outdoor Products
Kesk tee 10, Aaviku küla
Rae vald, Harju maakond
75305
kontakt.etj@husqvarna.ee

Finland

Oy Husqvarna Ab
Consumer Outdoor Products
Lautatarhankatu 8 B / PL 3
00581 HELSINKI
info@gardena.fi

France

GARDENA France
Immeuble Exposial
9 - 11 allée des Pierres Mayettes
ZAC des Barbanniers, B.P. 99
-F- 92232 GENNEVILLIERS
cedex
Tél. (+33) 01 40 85 30 40
service.consommateurs@
gardena.fr

Great Britain

Husqvarna UK Ltd
Preston Road
Aycliffe Industrial Park
Newton Aycliffe
County Durham
DL5 6UP
info.gardena@
husqvarna.co.uk

Greece

HUSQVARNA GREECE S.A.
Branch of Koropi
Ifestou 33A
Industrial Area Koropi
194 00 Athens - Greece
V.A.T. EL094094640
Phone: (+30) 210 66 20 225
info@husqvarna-consumer.gr

Hungary

Husqvarna
Magyarország Kft.
Ezred u. 1 - 3
1044 Budapest
Phone: (+36) 80 20 40 33
gardena@gardena.hu

Iceland

Ó. Johnson & Kaaber
Tunguhalsi 1
110 Reykjavik
ooj@ojk.is

Ireland

Michael McLoughlin & Sons
Hardware Limited
Long Mile Road
Dublin 12

Italy

GARDENA Italia S.p.A.
Via Donizetti 22
20020 Lainate (Mi)
Phone: (+39) 02.93.94.79.1
info@gardenaitalia.it

Japan

KAKUICHI Co. Ltd.
Sumitomo Realty &
Development Kojimachi
BLDG. 8F, 5-1 Nibanqyo,
Chiyoda-ku, Tokyo 102-0084
Phone: (+81) 33 264 4721
m_ishihara@kaku-ichi.co.jp

Latvia

SIA „Husqvarna Latvija“
Consumer Outdoor Products
Bākūžu iela 6, Rīga, LV-1024
info@husqvarna.lv

Lithuania

UAB Husqvarna Lietuva
Consumer Outdoor Products
Ateities pl. 77C
LT-52104 Kaunas
centras@husqvarna.lt

Luxembourg

Magasins Jules Neuberg
39, rue Jacques Stas
Luxembourg-Gasperich 2549
Case Postale No. 12
Luxembourg 2010
Phone: (+352) 40 14 01
api@neuberg.lu

Netherlands

GARDENA Nederland B.V.
Postbus 50176
1305 AD ALMERE
Phone: (+31) 36 521 00 00
info@gardena.nl

Neth. Antilles

Jonka Enterprises N.V.
Sta. Rosa Weg 196
P.O. Box 8200, Curaçao
Phone: (+599) 9 767 66 55
pgm@jonka.com

New Zealand

Husqvarna New Zealand Ltd.
PO Box 76437
Manukau City 2241
Phone: (+64) (09) 9202410

Norway

GARDENA
Husqvarna Consumer Outdoor
Products
Salgskontor Norge
Kleiveveien 6
1540 Vestby
info@gardena.no

Poland

Husqvarna Poland Spółka z o.o.
Oddział w Szymanowie
Szymanów 9 d
05-532 Baniocha
Phone: (+48) 22 727 56 90
gardena@gardena.pl

Portugal

GARDENA Portugal Lda.
Sintra Business Park
Edifício 1, Fração 0-G
2710-089 Sintra
Phone: (+351) 21 922 85 30
info@gardena.pt

Romania

MADEX INTERNATIONAL SRL
Soseaua Odaii 117-123,
Sector 1,
București, RO 013603
Phone: (+40) 21 352 76 03
madex@ines.ro

Russia

ООО ГАРДЕНА РУС
123007, г. Москва
Хорошевское шоссе, д. 32А
Тел.: (+7) 495 380 31 92
info@gardena-rus.ru

Singapore

Hy - Ray PRIVATE LIMITED
40 Jalan Pemimpin
02-08 Tat Ann Building
Singapore 577185
Phone: (+65) 6253 2277
shiyang@hyray.com.sg

Slovak Republic

GARDENA spol. s r.o.
Tuřanka 115
627 00 Brno
Phone: (+420) 548 217 777
gardena@gardenabrn.cz

Slovenia

GARDENA d.o.o.
Brodšiče 15
1236 Trzin
Phone: (+386) 1 580 93 32
servis@gardena.si

South Africa

GARDENA
South Africa (Pty.) Ltd.
P.O. Box 11534
Vorna Valley 1686
Phone: (+27) 11 315 02 23
sales@gardena.co.za

Spain

GARDENA IBÉRICA S.L.U.
C/ Basauri, nº 6
La Florida
28023 Madrid
Phone: (+34) 91 708 05 00
atencioncliente@gardena.es

Sweden

GARDENA
Husqvarna Consumer Outdoor
Products
Försäljningskontor Sverige
Box 9003
200 39 Malmö
info@gardena.se

Switzerland / Schweiz

GARDENA Schweiz AG
Consumer Products
Industriestrasse 10
5506 Mägenwil
Phone: (+41) (0) 848 800 464
info@gardena.ch

Turkey

GARDENA / Dost Diş Ticaret
Müessesilik A.Ş. Sanayi
Çad. Adil Sokak No. 1
Kartal - Istanbul
Phone: (+90) 216 38 93 939
info@gardena-dost.com.tr

Ukraine / Україна

ТОВ «ГАРДЕНА УКРАЇНА»
Васильківська, 34, 204-Г
03022, Київ
Тел. (+38 044) 498 39 02
info@gardena.ua

1481-20.960.15/1008
© GARDENA
Manufacturing GmbH
D-89070 Ulm
http://www.gardena.com