

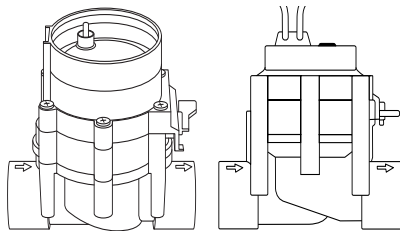

<b>D</b>	<b>Betriebsanleitung</b> Bewässerungsventil
<b>GB</b>	<b>Operating Instructions</b> Irrigation Valve
<b>F</b>	<b>Mode d'emploi</b> Electrovanne
<b>NL</b>	<b>Instructies voor gebruik</b> Beregeningsventiel
<b>S</b>	<b>Bruksanvisning</b> Ventil
<b>DK</b>	<b>Bruksanvisning</b> Vandingsventil
<b>FIN</b>	<b>Käyttöohje</b> Kasteluventtiili
<b>N</b>	<b>Bruksanvisning</b> Vanningsventil
<b>I</b>	<b>Istruzioni per l'uso</b> Valvola cordless



9V Art. 1251

24V Art. 1278

<b>E</b>	<b>Manual de instrucciones</b> Válvula de riego
<b>P</b>	<b>Instruções de utilização</b> Válvula de Irrigação
<b>RO</b>	<b>Instrucțiuni de utilizare</b> Electrovalvă
<b>TR</b>	<b>Kullanma kılavuzu</b> Solenoid vana

# GARDENA Irrigation Valve



Translation of the original instructions from German.

Please read these operating instructions carefully and observe the notes given. Use these operating instructions to familiarise yourself with the Irrigation Valve, its correct use and the notes on safety.



For safety reasons, children under 16 as well as persons not familiar with these operating instructions should not use this Irrigation Valve. Persons with reduced physical or mental abilities may use the product only if they are supervised or instructed by a responsible person. Children must be supervised to ensure that they do not play with the product. Never operate the product when you are tired, ill or under the influence of alcohol, drugs or medicine.

→ Please keep these operating instructions in a safe place.

## Contents

1. Where to Use Your GARDENA Irrigation Valve .....	15
2. Safety Instructions .....	16
3. Initial Operation .....	17
4. Operation .....	20
5. Trouble-Shooting .....	20
6. Protection against Frost .....	21
7. Technical Data .....	23
8. Service / Warranty .....	23

# 1. Where to Use Your GARDENA Irrigation Valve

## *Intended use*

The Irrigation Valves are intended solely for outdoor use for fully automatic control of individual irrigation systems. It is a benefit to arrange a watering system into separate sections in case of varying watering needs for different plant areas or if there is insufficient water available for simultaneous operation of the entire watering system.

The Irrigation Valve is installed upstream in the watering system (e. g. Pop-up Sprinklers; Micro-Drip-System), for example, in the ground.

## *Please note*

Compliance with the enclosed operating instructions provided by GARDENA is a prerequisite for proper use of the Irrigation Valve.

### 9V:

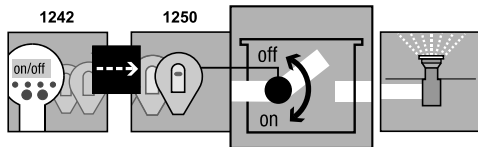

The Irrigation Valve **1251** forms part of an irrigation system in conjunction with the Programming Unit **1242** and the Control Unit **1250**.

### 24V:

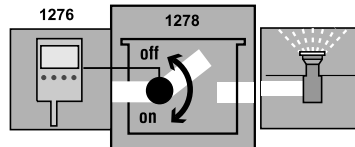

The Irrigation Valve **1278** forms part of an irrigation system in conjunction with the Watering Controller **1276**.



The Irrigation Valve must only be used in conjunction with the – 9 V Control Units; Radio Receivers / 24 V Watering Controller – approved by GARDENA.

## 2. Safety Instructions

---

### *Blocking the Irrigation Valve*

→ Please observe the notes on safety in the operating instructions.

**9 V and 24 V products are not interchangeable.**

→ **In the case of dirty water, the GARDENA Central Filter Art. No. 1510 must be installed upstream in the watering system.**

### *Water pressure*

The function of your watering system depends on the available water pressure. Therefore, care should be taken not to overlap watering cycles of the various watering circuits and to ensure that the watering circuits you have planned will be supplied with sufficient water at an adequate pressure.

Please refer to the planning instructions in the special brochure entitled “Watering Systems – Sprinkler System Planning Guide” available from GARDENA.

### 3. Initial Operation

If the Irrigation Valve is installed below ground level, it must be installed in a sturdy and step-proof valve mount ① (valve box) e.g. GARDENA Art. No. 1254/1255/1290/1292.

**Install the valve mount:**

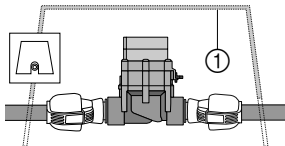
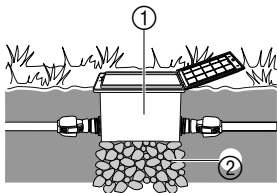

1. Draw up a plan (an example is shown in the figure below).

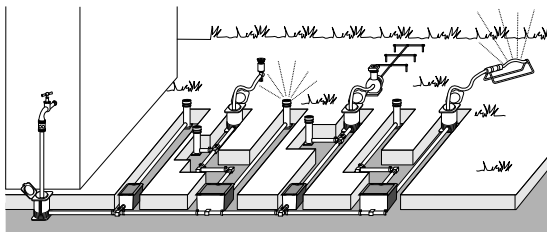

Additional information is provided in the GARDENA Sprinkler System Planning Guide which is available from your GARDENA dealer.

2. For underground installation, place a layer of coarse gravel ② underneath the valve mount ①.

*This ensures proper drainage of the box.*

### **Installing the Irrigation Valve without a Valve Box:**

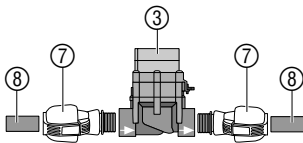

3. Install the valve box with the top edge of the box at ground level.

*This avoids damage when mowing the lawn.*

Please refer to the relevant operating instructions for information on how to install the Irrigation Valves in GARDENA Valve Boxes V1 and V3.

The integrated solenoid valve works only correctly with the Irrigation Valve connected in flow direction.



#### **Flow direction**

→ Pay attention to the flow direction (arrows) when installing the Irrigation Valve ③.

→ Seal the screw connections with PTFE sealing tape, **Art. 7219**.

#### **Connecting GARDENA Connecting pipes ⑧ (2700/2701/2704/2705/2718) or other commercially available connecting pipes:**

1. Screw a **GARDENA Connector ⑦ 2763** (1" = 25 mm) / **2769** (5/4" = 32 mm) into the Irrigation Valve ③.
2. Connect the GARDENA connecting pipes ⑧ or other commercially available connecting pipes (25 mm / 32 mm).

**Connect Soil Moisture Sensor  
or Rain Sensor electronic  
(optional):**

In conjunction with the programmed watering time, the moisture level of the soil or the natural precipitation can be taken into account for each Irrigation Valve.

When a sufficient moisture content of the soil is reached, a programme may be interrupted or activation of a programme may be suppressed.

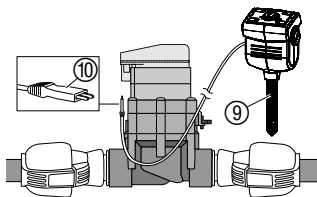

1. Place the Soil Moisture Sensor ⑨ in the area to be irrigated – or – the Rain Sensor electronic (if necessary with an extension cable) **outside** of the area to be irrigated.

2. **9V:** Plug the connector ⑩ into the sensor socket of the Control Unit.

**24V:** Insert plug ⑩ in the sensor connection of the Watering Control System **Art. 1276** (s. Operating Instructions **Art. 1276**).

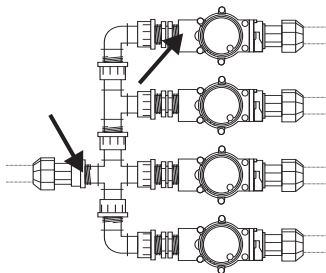

**Conventional installation :**

If using **Art. 2750 / 2751 / 2752 / 2753 / 2755** the points marked with an arrow must be sealed with sealing tape (e.g. **Art. No. 7219**).

## 4. Operation

### Adjusting valve control:

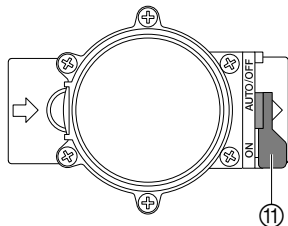

### Fully Automatic Control:

→ Set selection lever ⑪ to “**AUTO/OFF**”.

*Programme-controlled water flow to the watering system according to the programming in the Control Unit / Radio Receiver.*

An automatically opened valve cannot be closed manually.

### Manual Control:

→ Set selection lever ⑪ to “**ON**”.

*Permanent water flow, independent of the programming.*

## 5. Trouble-Shooting

Fault	Possible Causes	Remedy
Solenoid valve does not open, no water flow	No water supply.	→ Turn on water supply.
	Control Unit / Radio Receiver / Watering Controller not connected correctly to Irrigation Valve.	→ Connect Control Unit / Radio Receiver / Watering Controller correctly to Irrigation Valve.



Fault	Possible Causes	Remedy
Solenoid valve does not close, continuous water flow	Solenoid valve installed opposite to flow direction.	→ Turn solenoid valve (observe the flow direction).
	Selection lever ⑪ set to “ON”.	→ Set selection lever ⑪ to “AUTO/OFF”.



In the event of other faults please contact **GARDENA Service**.  
Repairs should only be carried out by **GARDENA service centres or dealers** authorised by GARDENA.

## 6. Protection against Frost

### *Winter storage:*

GARDENA Irrigation Valves are intended for outdoor use and are only frost-proof to a limited extent. The only way to protect your Irrigation Valves completely is to remove the valves before the frosty season begins. Alternatively, you can drain the pipeline system upstream and downstream of the Irrigation Valve.

### *Emptying the pipeline system UPSTREAM of the valve:*

1. Turn off the tap and disconnect the hose between the tap and the **GARDENA Water Connection Point Art. No. 2722 / Art. No. 2795**.

*This allows the air to flow freely and the supply line can be drained using the drain valve integrated in the Connecting Point.*

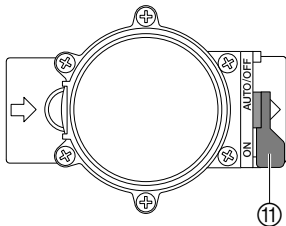

### **Emptying the pipeline system DOWNSTREAM of the valve:**

*This requires that the Connecting Point be installed deeper in the ground than the Irrigation Valve.*

2. If the watering system is directly connected to the water tap, turn off the water supply and open the venting tap.
3. Set the selection lever ⑪ of all valves to the “ON” position.
4. If you are using the GARDENA Valve Box V3, make sure you open the integrated drain cap.

**Requirement:** The Drainage Valve must be installed deeper than or at the same depth as the Irrigation Valve.

→ Install a GARDENA Drainage Valve **Art. No. 2760** immediately after the valve.

The system is drained automatically via the the GARDENA Drainage Valve.

**→ If neither of these requirements is fulfilled, the valve must be removed and stored in a place safe from frost.**

### **Disposal:**

*(in accordance with  
Directive 2012/19/EU)*



The product must not be added to normal household waste. It must be disposed of in line with local environmental regulations.

→ Important: Make sure that the unit is disposed of via your municipal recycling collection centre.

## 7. Technical Data

<b>Solenoid Valve</b>	<b>9V (Art. No. 1251)</b>	<b>24V (Art. No. 1278)</b>
<b>Voltage</b>	9V DC	24V AC
<b>Operating pressure</b>	0.5 to 12 bar	0.5 to 12 bar
<b>Flow medium</b>	clean fresh water	clean fresh water
<b>Max. water temperature</b>	40 °C	40 °C

## 8. Service / Warranty

GARDENA guarantees this product for 2 years (from date of purchase). This guarantee covers all serious defects of the unit that can be proved to be material or manufacturing faults. Under warranty we will either replace the unit or repair it free of charge if the following conditions apply:

- The unit must have been handled properly and in keeping with the requirements of the operating instructions.
- Neither the purchaser or a non-authorized third party have attempted to repair the unit.

Faults with the Irrigation Valve caused by incorrectly installed batteries or leaking batteries in the Control Unit / Radio Receiver are not covered by the guarantee.

This manufacturer's guarantee does not affect the user's existing warranty claims against the dealer/seller.

If a fault occurs with your Irrigation Valve, please return the faulty unit together with a copy of the receipt and a description of the fault, with postage paid to one of the GARDENA Service Centres listed on the back of these operating instructions.

Bild Nr. Picture No.	Ersatzteil-Nr. Spare Part No.	Bezeichnung <b>Bewässerungsventil 9V/1"</b> <b>Art. - Nr. 1251</b>	Description <b>Watering Valve 9V/1"</b> <b>Art. No. 1251</b>
19 - 36	1251-00.500.00	Bew. Ventil 9V/1" (=Art.1251)	Watering valve 9V/1" (= Art.1251)
19	1815-00.610.27	Steuerdüse, rot	Control nozzle, red
20	1251-00.500.26	Ventildeckel	Valve cover
21	913-00.680.01	O-Ring 7,5 x 2	O-Ring 7,5 x 2
22+21	1251-00.701.00	Kücken, vollst.	Mixer dial, cpl.
23	1672-00.600.11	O-Ring 24 x 2	O-Ring 24 x 2
24	1174-00.617.00	Magnetplatte, vollst.	Magnetic plate, cpl.
25	1174-00.610.11	Druckfeder, klein	Pressure spring, small
26	1251-00.510.00	Elektromagnet, vollst.	Electric magnet, cpl.
27	1174-00.610.07	Blechschraube 3,5 x 25-F-H	Sheet metal screw 3,5 x 25-F-H
28	1251-00.500.21	Blechschraube 4,2 x 60	Sheet metal screw 4,2 x 60 (6 x)
29	1174-00.610.08	Druckfeder, gross	Pressure spring, large
30 - 34	1251-00.520.00	Membrane, vollst.	Diaphragm
35	1251-00.500.11	Stützring	Support ring
36	1251-00.500.06	Ventilkörper	Valve body
	1251-00.540.00	Feinfilter	Fine filter



Bewässerungsventil  
Art. 1251

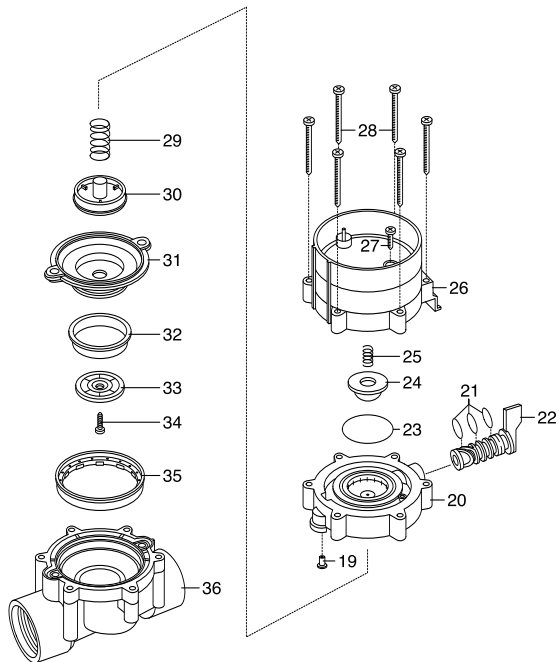

**D Produkthaftung**

Wir weisen ausdrücklich darauf hin, dass wir nach dem Produkthaftungsgesetz nicht für durch unsere Geräte hervorgerufene Schäden einzustehen haben, sofern diese durch unsachgemäße Reparatur verursacht oder bei einem Teileaustausch nicht unsere Original GARDENA Teile oder von uns freigegebene Teile verwendet werden und die Reparatur nicht vom GARDENA Service oder dem autorisierten Fachmann durchgeführt wird. Entsprechendes gilt für Ergänzungsteile und Zubehör.

**GB Product Liability**

We expressly point out that, in accordance with the product liability law, we are not liable for any damage caused by our units if it is due to improper repair or if parts exchanged are not original GARDENA parts or parts approved by us, and, if the repairs were not carried out by a GARDENA Service Centre or an authorised specialist. The same applies to spare parts and accessories.

**F Responsabilité**

Nous vous signalons expressément que GARDENA n'est pas responsable des dommages causés par ses appareils, dans la mesure où ces dommages seraient causés suite à une réparation non conforme, dans la mesure où, lors d'un échange de pièces, les pièces d'origine GARDENA n'auraient pas été utilisées, ou si la réparation n'a pas été effectuée par le Service Après-Vente GARDENA ou l'un des Centres SAV agréés GARDENA. Ceci est également valable pour tout ajout de pièces et d'accessoires autres que ceux préconisés par GARDENA.

**NL Productaansprakelijkheid**

Wij wijzen er nadrukkelijk op, dat wij op grond van de wet aansprakelijkheid voor producten niet aansprakelijk zijn voor schade ontstaan door onze apparaten, indien deze door onvakkundige reparatie veroorzaakt zijn, of er bij het uitwisselen van onderdelen geen gebruik gemaakt werd van onze originele GARDENA onderdelen of door ons vrijgegeven onderdelen en de reparatie niet door de GARDENA technische dienst of de bevoegde vakman uitgevoerd werd. Ditzelfde geldt voor extra-onderdelen en accessoires.

**S Produktansvar**

Tillverkaren är inte ansvarig för skada som orsakats av produkten om skadan beror på att produkten har reparerats felaktigt eller om, vid reparation eller utbyte, andra än Original GARDENA reservdelar har använts. Samma sak gäller för kompletteringsdelar och tillbehör.

**DK Produktansvar**

Vi gør udtrykkeligt opmærksom på at i henhold til produktansvarsloven er vi ikke ansvarlige for skader forårsaget af vores udstyr, hvis det skyldes uautoriserede reparationer eller hvis dele er skiftet ud og der ikke er anvendt originale GARDENA dele eller dele godkendt af os, eller hvis reparationerne ikke er udført af GARDENA-service eller en autoriseret fagmand. Det samme gælder for ekstra udstyr og tilbehør.

<p><b>D EG-Konformit�tserkl�ring</b></p> <p>Der Undertecknede Husqvarna AB, 561 82 Huskvarna, Sweden best�tigt, dass die nachfolgend bezeichneten Ger�te in der von uns in Verkehr gebrachten Ausf�hrung die Anforderungen der harmonisierten EU-Richtlinien, EU-Sicherheitsstandards und produktspezifischen Standards erf�llen. Bei einer nicht mit uns abgestimmten �nderung der Ger�te verliert diese Erkl�rung ihre G�ltigkeit.</p>	<p><b>DK EU Overensstemmelse certificat</b></p> <p>Undertegnede Husqvarna AB, 561 82 Huskvarna, Sweden bekr�fter hermed, at enheder listet herunder, ved afsendelse fra fabrikken, er i overensstemmelse med harmoniserede EU retningslinier, EU sikkerhedsstandarder og produkt-specifikationsstandarder. Dette certificat tr�der ud af kraft hvis enhederne er �ndret uden vor godkendelse.</p>
<p><b>GB EU Declaration of Conformity</b></p> <p>The undersigned Husqvarna AB, 561 82 Huskvarna, Sweden, hereby certifies that, when leaving our factory, the units indicated below are in accordance with the harmonised EU guidelines, EU standards of safety and product specific standards. This certificate becomes void if the units are modified without our approval.</p>	<p><b>FIN EY-vaatimustenmukaisuusvakuutus</b></p> <p>Allekirjoittanut Husqvarna AB, 561 82 Huskvarna, Sweden vakuuttaa, ett� allamainitut laitteet t�ytt�v�t tehtaaltamme l�htiess�n yhdenmukaistettujen EY-direktiivien, EY-turvallisuusstandardien ja tuotekohtaisten standardien vaatimukset. Laitteisiin tehdyt muutokset, joista ei ole sovittu kanssamme, johtavat t�m�n vakuutuksen raukkaamiseen.</p>
<p><b>F Certificat de conformit� aux directives europ�ennes</b></p> <p>Le constructeur, soussign� : Husqvarna AB, 561 82 Huskvarna, Sweden, d�clare qu'� la sortie de ses usines le mat�riel neuf d�sign� ci-dessous �tait conforme aux prescriptions des directives europ�ennes �nonc�es ci-apr�s et conforme aux r�gles de s�curit� et autres r�gles qui lui sont applicables dans le cadre de l'Union europ�enne. Toute modification port�e sur ce produit sans l'accord express de Husqvarna supprime la validit� de ce certificat.</p>	<p><b>I Dichiarazione di conformit� alle norme UE</b></p> <p>La sottoscritta Husqvarna AB, 561 82 Huskvarna, Sweden, certifica che il prodotto qui di seguito indicato, nei modelli da noi commercializzati, � conforme alle direttive armonizzate UE nonch� agli standard di sicurezza e agli standard specifici di prodotto. Qualunque modifica apportata al prodotto senza nostra specifica autorizzazione invalida la presente dichiarazione.</p>
<p><b>NL EU-overeenstemmingsverklaring</b></p> <p>Ondergetekende Husqvarna AB, 561 82 Huskvarna, Sweden, bevestigt, dat het volgende genoemde apparaat in de door ons in de handel gebrachte uitvoering voldoet aan de eis van, en in overeenstemming is met de EU-richtlijnen, de EU-veiligheidsstandaard en de voor het product specifieke standaard. Bij een niet met ons afgestemde verandering aan het apparaat verliest deze verklaring haar geldigheid.</p>	<p><b>E Declaraci�n de conformidad de la UE</b></p> <p>El que subscribe Husqvarna AB, 561 82 Huskvarna, Sweden, declara que la presente mercanc�a, objeto de la presente declaraci�n, cumple con todas las normas de la UE, en lo que a normas t�cnicas, de homologaci�n y de seguridad se refiere. En caso de realizar cualquier modificaci�n en la presente mercanc�a sin nuestra previa autorizaci�n, esta declaraci�n pierde su validez.</p>
<p><b>S EU Tillverkarintyg</b></p> <p>Undertecknad firma Husqvarna AB, 561 82 Huskvarna, Sweden, intygat h�med att nedan n�mnda produkter �verensst�mmer med EU:s direktiv, EU:s s�kerhetsstandard och produktspecifikation. Detta intyg upph�r att g�lla om produkten �ndras utan v�rt tillst�nd.</p>	<p><b>P Certificado de conformidade da UE</b></p> <p>Os abaixo mencionados Husqvarna AB, 561 82 Huskvarna, Sweden, por este meio certificam que ao sair da f�brica o aparelho abaixo mencionado est� de acordo com as directrizes harmonizadas da UE, padr�es de seguran�a e de produtos espec�ficos. Este certificado ficar� nulo se a unidade for modificada sem a nossa aprova�o.</p>



<p><b>RO UE - Certificat de conformitate</b></p> <p>Prin prezenta Husqvarna AB, 561 82 Huskvarna, Sweden, certifica faptul ca, in momentul in care produsele mentionate mai jos ies din fabrica sunt in concordanta cu directivele UE, standardele de siguranta UE si standardele specifice ale produsului UE. Acest certificat devine nul in cazul modificării aparatului fără aprobarea noastră.</p>	<p>EU-Richtlinien: EU directives: Directives européennes : EU-richtlijnen: EU direktiv: EU Retningslinier: EY-direktiivit:</p>
<p>Bezeichnung des Gerätes:            Bewässerungsventil Description of the unit:            Irrigation Valve Désignation du matériel :        Electrovanne Omschrijving van het apparaat:    Beregeningsventiel Produktbeskrivning:                Ventil Beskrivelse af enhederne:        Vandingsventil Laitteiden nimitys:                Kasteluventtiili Descrizione del prodotto:        Valvola cordless Descripción de la mercancía:    Válvula de riego Descrição do aparelho:            Válvula de Irrigação Descrierea articolelor:            Electrovalvă</p>	<p style="text-align: right;"><b>2011/65/EC</b></p> <p>Direttive UE: Normativa UE: Directizes da UE: Directive UE:</p> <p>Hinterlegte Dokumentation:      GARDENA Technische Dokumentation M. Kugler 89079 Ulm Deposited Documentation:        GARDENA Technical Documentation M. Kugler 89079 Ulm Documentation déposée :        Documentation technique GARDENA M. Kugler 89079 Ulm</p>
<p>Typ:                                        Art.-Nr.: Type:                                        Art. No.: Type :                                        Référence : Typ:                                        Art. nr.: Type:                                        Art.nr.:                                        <b>1251</b> Type:                                        Varenr. : Typpit:                                        Art.-n:o. :                                        <b>1278</b> Modello:                                        Art. : Tipo:                                        Art. Nº: Tipo:                                        Art. Nº: Tipuri:                                        Nr art.:</p>	<p>Anbringungsjaar der CE-Kennzeichnung: Year of CE marking: Date d'apposition du marquage CE : Installatiejaar van de CE-aanduiding: CE-Märkningsår: CE-Mærkningsår:                                        <b>2014</b> CE-merkin kiinnitysvuosi: Anno di rilascio della certificazione CE: Colocación del distintivo CE: Ano de marcação pela CE: Anul de marcare CE:</p>

Ulm, den 14.01.2014  
Ulm, 14.01.2014  
Fait à Ulm, le 14.01.2014  
Ulm, 14-01-2014  
Ulm, 2014.01.14.  
Ulm, 14.01.2014  
Ulmissa, 14.01.2014  
Ulm, 14.01.2014  
Ulm, 14.01.2014  
Ulm, 14.01.2014

Der Bevollmächtigte  
Authorised representative  
Représentant légal  
Gemachtigde  
Behörig Firmatecknare  
Teknisk direktør  
Valtuutettu edustaja  
Rappresentante autorizzato  
Representante autorizado  
Representante autorizado  
Vodja tehničnega oddelka



Reinhard Pompe  
(Vice President)

**Deutschland / Germany**

GARDENA GmbH  
Central Service  
Hans-Lorenser-Straße 40  
D-89079 Ulm  
Produktfragen:  
(+49) 731 490-123  
Reparaturen:  
(+49) 731 490-290  
service@gardena.com

**Albania**

COBALT Sh.p.k.  
Rr. Siri Kodra  
1000 Tirana

**Argentina**

Husqvarna Argentina S.A.  
Av.del Libertador 5954 -  
Piso 11 - Torre B  
(C1428ARP) Buenos Aires  
Phone: (+54) 11 5194 5000  
info.gardena@  
ar.husqvarna.com

**Armenia**

Garden Land Ltd.  
61 Tigran Mets  
0005 Yerevan

**Australia**

Husqvarna Australia Pty. Ltd.  
Locked Bag 5  
Central Coast BC  
NSW 2252  
Phone: (+61) (0) 2 4352 7400  
customer.service@  
husqvarna.com.au

**Austria / Österreich**

Husqvarna Austria GmbH  
Consumer Products  
Industriezeile 36  
4010 Linz  
Tel.: (+43) 732 77 01 01 -90  
consumer.service@husqvarna.at

**Azerbaijan**

Firm Progress  
a. Aliyev Str. 26A  
1052 Baku

**Belgium**

GARDENA Belgium NV/SA  
Sterrebeekstraat 163  
1930 Zaventem  
Phone: (+32) 2 720 92 12  
Mail: info@gardena.be

**Bosnia / Hercegovina**

SILK TRADE d.o.o.  
Industrijska zona Bukva bb  
74260 Tešanj

**Brazil**

Husqvarna do Brasil Ltda  
Av. Francisco Matarazzo,  
1400 – 19º andar  
São Paulo - SP  
CEP: 05001-903  
Tel: 0800-112252  
marketing.br.husqvarna@  
husqvarna.com.br

**Bulgaria**

Хускварна България ЕООД  
Бул. „Андрей Ляпчев“ № 72  
1799 София  
Тел.: (+359) 02/975 30 76  
www.husqvarna.bg

**Canada / USA**

GARDENA Canada Ltd.  
100 Summerlea Road  
Brampton, Ontario L6T 4X3  
Phone: (+1) 905 792 93 30  
info@gardenacanada.com

**Chile**

Maquinarias Agroforestales  
Ltda. (Maga Ltda.)  
Santiago, Chile  
Avda. Chesterton  
# 8355 comuna Las Condes  
Phone: (+56) 2 202 4417  
Dalton@maga.cl  
Zipcode: 7560330

Temuco, Chile  
Avda. Valparaiso # 01466  
Phone: (+56) 45 222 126  
Zipcode: 4780441

**China**

Husqvarna (China) Machinery  
Manufacturing Co., Ltd.  
No. 1355, Jia Xin Rd.,  
Ma Lu Zhen, Jia Ding Dist.,  
Shanghai  
201801  
Phone: (+86) 21 59159629  
Domestic Sales  
www.gardena.com.cn

**Colombia**

Husqvarna Colombia S.A.  
Calle 18 No. 68 D-31, zona  
Industrial de Montevideo  
Bogotá, Cundinamarca  
Tel. 571 2922700 ext. 105  
jairo.salazar@  
husqvarna.com.co

**Costa Rica**

Compania Exim  
Euroberoamericana S.A.  
Los Colegios, Moravia,  
200 metros al Sur del Colegio  
Saint Francis - San José  
Phone: (+506) 297 68 83  
exim\_euro@racsa.co.cr

**Croatia**

SILK ADRIA d.o.o.  
Josipa Lončara 3  
10090 Zagreb  
Phone: (+385) 1 3794 580  
silk.adria@zg.t-com.hr

**Cyprus**

Med Marketing  
17 Digeni Akrita Ave  
P.O. Box 27017  
1641 Nicosia

**Czech Republic**

Husqvarna Cesko s.r.o.  
Türkova 2319/5b  
149 00 Praha 4 – Chodov  
Bezplatná infolinka:  
800 100 425  
servis@cz.husqvarna.com

**Denmark**

GARDENA / Husqvarna  
Consumer Outdoor Products  
Salgsafdeling Danmark  
Box 9003  
S-200 39 Malmö  
info@gardena.dk

**Dominican Republic**

BOSQUESA, S.R.L  
Carretera Santiago Licey  
Km. 5 ½  
Esquina Copal II.  
Santiago, Dominican Republic  
Phone: (+809) 736-0333  
joserbosquesa@claro.net.do

**Ecuador**

Husqvarna Ecuador S.A.  
Arupos E1-181 y 10 de Agosto  
Quito, Pichincha  
Tel. (+593) 22800739  
francisco.jacome@  
husqvarna.com.ec

**Estonia**

Husqvarna Eesti OÜ  
Consumer Outdoor Products  
Kesk tee 10, Aaviku küla  
Rae vald  
Harju maakond  
75305 Estonia  
kontakt.etj@husqvarna.ee

**Finland**

Oy Husqvarna Ab  
Consumer Outdoor Products  
Lautatarhankatu 8 B/ PL 3  
00581 HELSINKI  
info@gardena.fi

**France**

GARDENA France  
Immeuble Exposial  
9-11 allée des Pierres Mayettes  
ZAC des Barbannières, B.P. 99  
-F- 92232 GENNEVILLIERS  
cedex  
Tél. (+33) 01 40 85 30 40  
service.consommateurs@  
gardena.fr

**Georgia**

ALD Group  
Beliasvili 8  
1159 Tbilisi

**Great Britain**

Husqvarna UK Ltd  
Preston Road  
Aycliffe Industrial Park  
Newton Aycliffe  
County Durham  
DL5 6UP  
info.gardena@  
husqvarna.co.uk

**Greece**

ΕΛΛΑΣ Α.Ε.Β.Ε.  
Υπ/μα Ηφείστου 33Α  
Βλ. Πλ. Κορωπίου  
194 00 Κορωπί Αττικής  
V.A.T. EL094094640  
Phone: (+30) 210 66 20 225  
info@husqvarna-consumer.gr

**Hungary**

Husqvarna Magyarorszag Kft.  
Ezred u. 1-3  
1044 Budapest  
Telefon: (+36) 1 251-4161  
vevoszolgalat.husqvarna@  
husqvarna.hu

**Iceland**

Ó. Johnson & Kaaber  
Tunguhalsi 1  
110 Reykjavik  
ooj@ojk.is

**Ireland**

Husqvarna UK Ltd  
Preston Road  
Aycliffe Industrial Park  
Newton Aycliffe  
County Durham  
DL5 6UP  
info.gardena@  
husqvarna.co.uk

**Italy**

Husqvarna Italia S.p.A.  
Via Como 72  
23868 VALMADRERA (LC)  
Phone: (+39) 0341.203.111  
info@gardenaitalia.it

**Japan**

KAKUICHI Co. Ltd.  
Sumitomo Realty &  
Development Kojimachi  
BLDG., 8F  
5-1 Nibanncyo  
Chiyoda-ku  
Tokyo 102-0084  
Phone: (+81) 33 264 4721  
m\_ishihara@kaku-ichi.co.jp

**Kazakhstan**

LAMED Ltd.  
155/1, Tazhibayevoi Str.  
050060 Almaty  
IP Schmidt  
Abayavenue 3B  
110 005 Kostanay

**Korea**

Kyung Jin Trading CO.,LTD.  
107-4, SunDuk Bld.,  
YangJae-dong,  
Seochu-gu,  
Seoul, (zipcode: 137-891)  
Phone: (+82) (0)2 574-6300

**Kyrgyzstan**

Alye Maki  
av. Moladaya Guardir J 3  
720014 Bishkek

**Latvia**

Husqvarna Latvija  
Consumer Outdoor Products  
Bakūžu iela 6  
LV-1024 Rīga  
info@husqvarna.lv

**Lithuania**

UAB Husqvarna Lietuva  
Consumer Outdoor Products  
Ateities pl. 77C  
LT-52104 Kaunas  
centras@husqvarna.lt

**Luxembourg**

Magasins Jules Neuberg  
39, rue Jacques Stas  
Luxembourg-Gasperich 2549  
Case Postale No. 12  
Luxembourg 2010  
Phone: (+352) 40 14 01  
api@neuberg.lu

**Mexico**

AFOSA  
Av. Lopez Mateos Sur # 5019  
Col. La Calma 45070  
Zapopan, Jalisco  
Mexico  
Phone: (+52) 33 3818-3434  
icornejo@afosa.com.mx

**Moldova**

Convel S.R.L.  
290A Muncestii Str.  
2002 Chisinau

**Netherlands**

GARDENA Nederland B.V.  
Postbus 50176  
1305 AD ALMERE  
Phone: (+31) 36 521 00 00  
info@gardena.nl

**Neth. Antilles**

Jonka Enterprises N.V.  
Sta. Rosa Weg 196  
P.O. Box 8200  
Curaçao  
Phone: (+599) 9 767 66 55  
pgm@jonka.com

**New Zealand**

Husqvarna New Zealand Ltd.  
PO Box 76-437  
Manukau City 2241  
Phone: (+64) (0) 9 9202410  
support.nz@husqvarna.co.nz

**Norway**

GARDENA  
Husqvarna Consumer  
Outdoor Products  
Salgskontor Norge  
Klevertveien 6  
1540 Vestby  
info@gardena.no

**Peru**

Husqvarna Perú S.A.  
Jr. Ramón Cárcamo 710  
Lima 1  
Tel: (+51) 1 3320400  
ext. 416  
juan.remuzgo@husqvarna.com

**Poland**

Husqvarna  
Udostępnienie  
Poland Spółka z o.o.  
ul. Wysockiego 15 b  
03-371 Warszawa  
Zapopan, Jalisco  
22 330 96 00  
gardena@husqvarna.com.pl

**Portugal**

Husqvarna Portugal, SA  
Lagoa - Albarraque  
2635 - 595 Rio de Mouro  
Tel.: (+351) 21 922 85 30  
Fax : (+351) 21 922 85 36  
info@gardena.pt

**Romania**

Madex International Srl  
Soseaua Odaii 117 - 123,  
RO 013603  
București, S 1  
Phone: (+40) 21 352.76.03  
madex@ines.ro

**Russia**

ООО „Хускварна“  
141400, Московская обл.,  
г. Химки,  
улица Ленинградская,  
владение 39, стр.6  
Бизнес Центр  
„Химки Бизнес Парк“,  
помещение ОВ02\_04

**Serbia**

Domel d.o.o.  
Autoput za Novi Sad bb  
11273 Belgrade  
Phone: (+381) 1 18 48 88 12  
miroslav.jejina@domel.rs

**Singapore**

Hy-Ray PRIVATE LIMITED  
40 Jalan Pemimpin  
#02-08 Tat Ann Building  
Singapore 577185  
Phone: (+65) 6253 2277  
shiyang@hyray.com.sg

**Slovak Republic**

Husqvarna Česko s.r.o.  
Türkova 2319/5b  
149 00 Praha 4 - Chodov  
Bezplatná infolinka:  
800 154 044  
servis@sk.husqvarna.com

**Slovenia**

Husqvarna Austria GmbH  
Consumer Products  
Industriezeile 36  
4010 Linz  
Tel.: (+43) 732 77 01 01-90  
consumer.service@  
husqvarna.at

**South Africa**

Husqvarna  
South Africa (Pty) Ltd  
Postnet Suite 250  
Private Bag X6,  
Cascades, 3202  
South Africa  
Phone: (+27) 33 846 9700  
info@gardena.co.za

**Spain**

Husqvarna España S.A.  
C/ Basauri, nº 6  
La Florida  
28023 Madrid  
Phone: (+34) 91 708 05 00  
atencioncliente@gardena.es

**Suriname**

Agrofix n.v.  
Verlengde Hogestraat # 22  
Phone: (+597) 472426  
agrofix@sr.net  
Pobox : 2006  
Paramaribo  
Suriname-South America

**Sweden**

Husqvarna AB  
S-561 82 Huskvarna  
info@gardena.se

**Switzerland / Schweiz**

Husqvarna Schweiz AG  
Consumer Products  
Industriestrasse 10  
5506 Mägenwil  
Phone: (+41) (0) 62 887 37 90  
info@gardena.ch

**Turkey**

GARDENA Dost Diş Ticaret  
Müessesilik A.Ş.  
Sanayi Çad. Adil Sokak  
No: 1/B Kartal  
34873 Istanbul  
Phone: (+90) 216 38 93 939  
info@gardena-dost.com.tr

**Ukraine / Україна**

ТОВ «Хусварна Україна»  
вул. Васильківська, 34,  
офіс 204-р  
03022, Київ  
Тел. (+38) 044 498 39 02  
info@gardena.ua

**Uruguay**

FELI SA  
Entre Rios 1083 CP 11800  
Montevideo - Uruguay  
Tel: (+598) 22 03 18 44  
info@felisa.com.uy

**Venezuela**

Corporación Casa y Jardín C.A.  
Av. Caroní, Edif. Trezmen, PB.  
Colinas de Bello Monte.  
1050 Caracas.  
Tlf: (+58) 212 992 33 22  
info@casayjardin.net.ve

1251-20.960.18/0414  
© GARDENA  
Manufacturing GmbH  
D-89070 Ulm  
http://www.gardena.com